

1.5mm Compression Plates

- C151674
- C151465
- C151256
- C151152
- C151047
- C150943
- C150838
- C150734
- C150629
- C150525
- C150420

2.0mm Mini Plates

- MP20317
- MP20423
- MP20529
- MP20635
- MP20741

2.0mm Compression

- CP201892
- CP201682
- CP201472
- CP201262
- CP201052
- CP20842
- CP20737
- CP20632
- CP20527
- CP20422

2.0mm Round Hole Plates

- PR200843
- PR200840
- PR200738
- PR200735
- PR200633
- PR200630
- PR200528
- PR200525
- PR200423
- PR200420
- PR200213

2.0mm Biological Healing Plates

- BHP2008080
- BHP2008075
- BHP2008070
- BHP2008065
- BHP2007060

2.0mm ASYM® Plates

- ASYM20030437
- ASYM20030542
- ASYM20030647
- ASYM20030752
- ASYM20040652
- ASYM20030857
- ASYM20040757
- ASYM20030962
- ASYM20040862
- ASYM20031067
- ASYM20040967
- ASYM20031172
- ASYM20041072

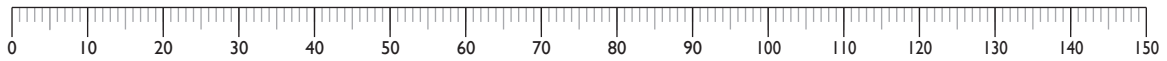

2.4mm Compression Plates

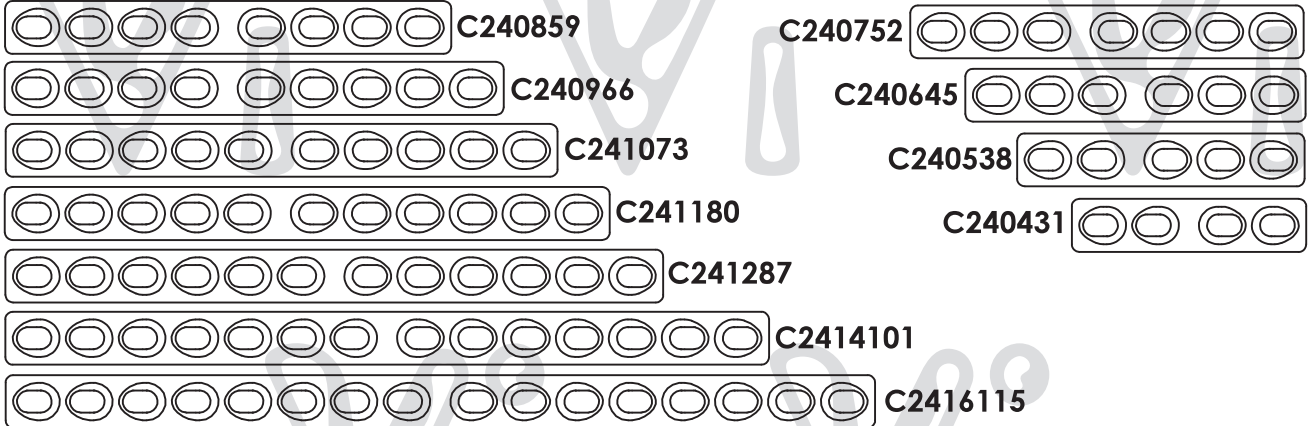

2.4mm ASYM[®] Plates

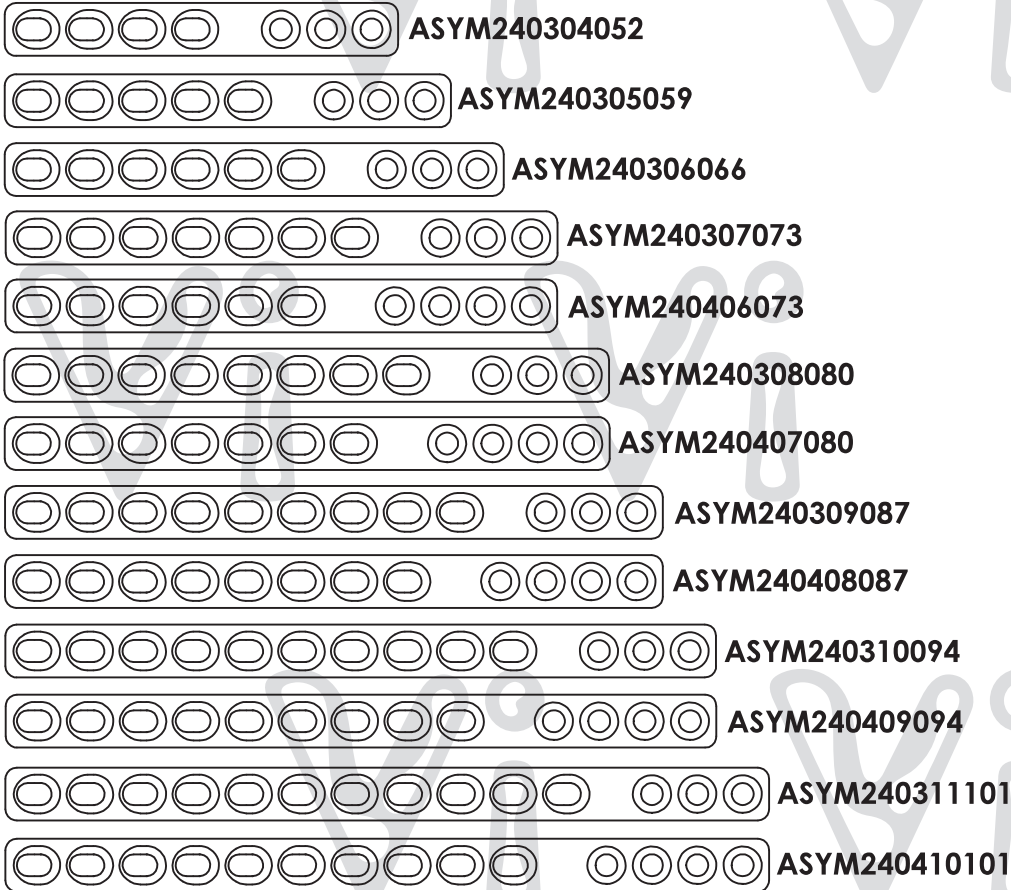

2.4mm Limited Contact Compression Plates

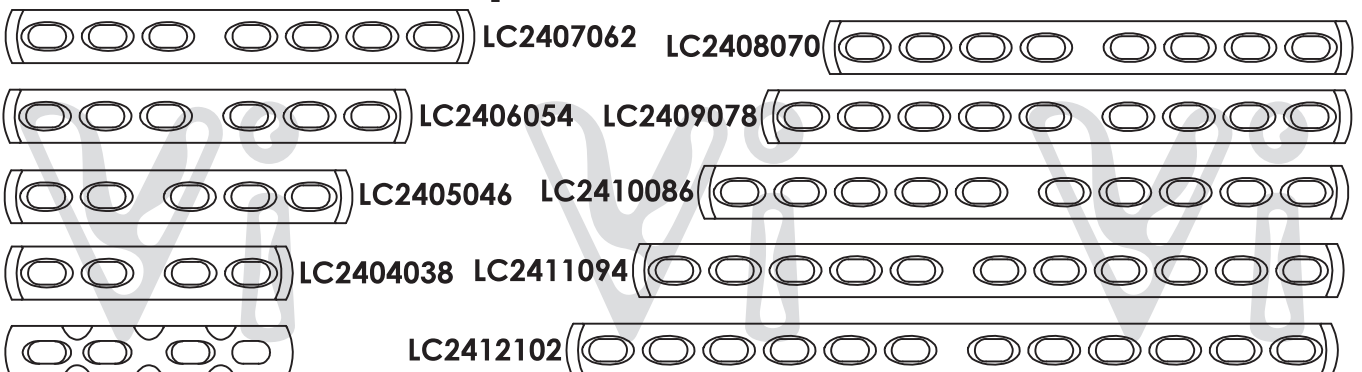

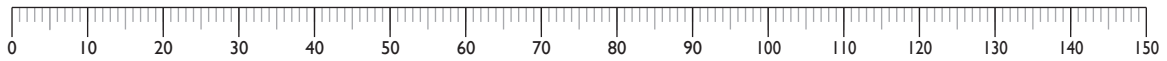

2.7mm Compression Plates

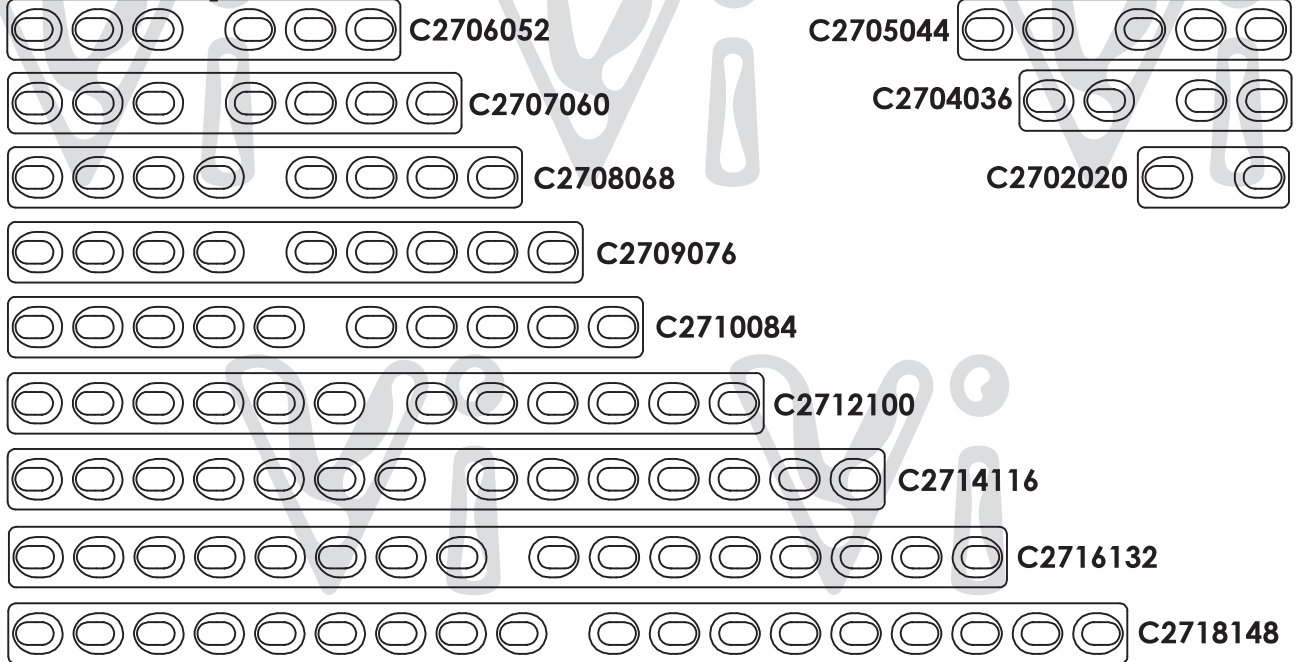

2.7mm ASYM[®] Plates



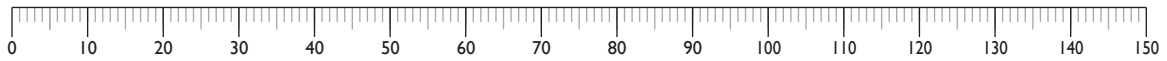

PR270851



PR270848



PR270745



PR270742



PR270639



PR270636



PR270215



PR270424



PR270427



PR270530



PR270533

2.7mm Heavy Duty Round Hole Plates



HPR270962

HPR271062



HPR270956

HPR271068



HPR270856

HPR271168



HPR270850

HPR271174



HPR270750

HPR271274



HPR270744

HPR271280

2.7mm Biological Healing Plates



BHP2706063



BHP2707067



BHP2707073



BHP2708075

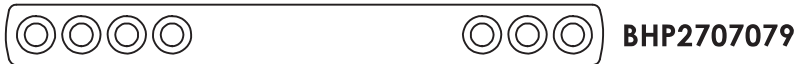

BHP2707079



BHP2708081

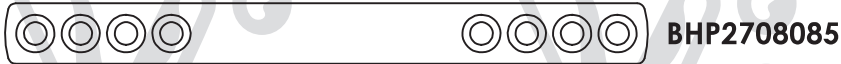

BHP2708085

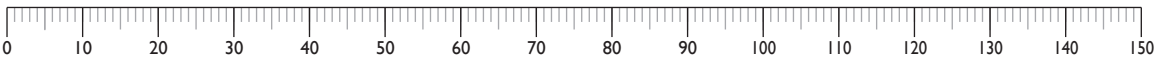

C3520242

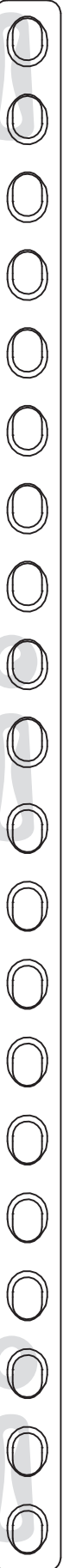

C3518218

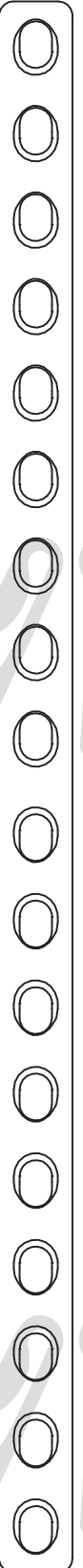

C3516194

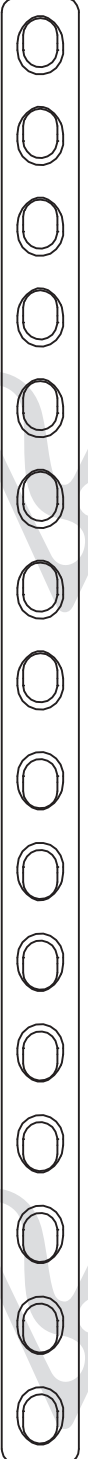

C3514170



2.7mm Limited Contact Compression Plates

LC2702026

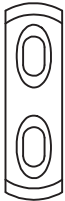

Reverse Detail



LC2704044



LC2705053



LC2706062



LC2707071



LC2708080



LC2709089



LC2710098

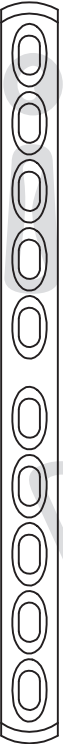

LC2712116



LC2712134



LC2716152



3.5mm Compression Plates

C3512146



C3510122



C3509111



C3508098

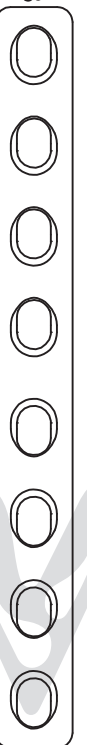

C3507086



C3506074

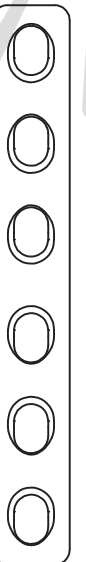

C3505062

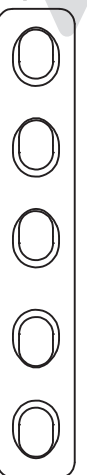

C3504050



C3503038



C3502026



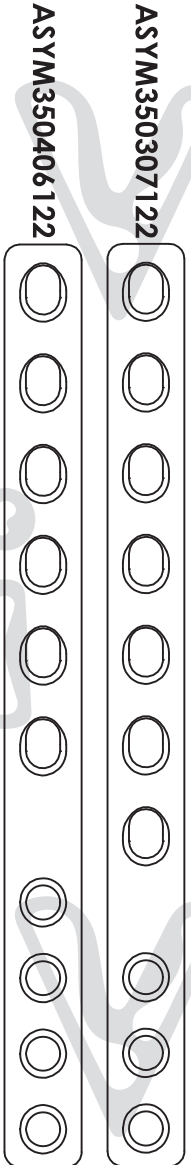
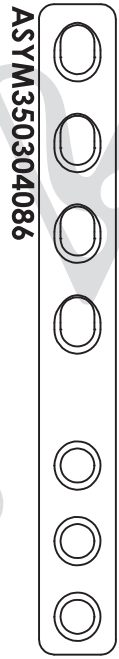
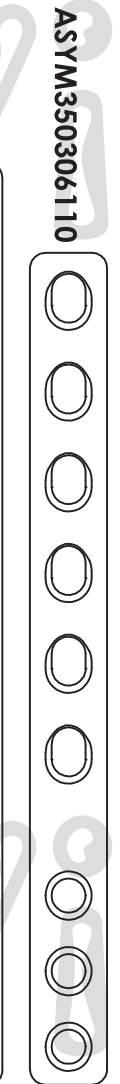
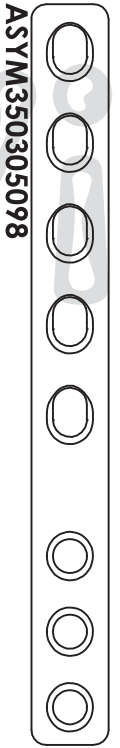
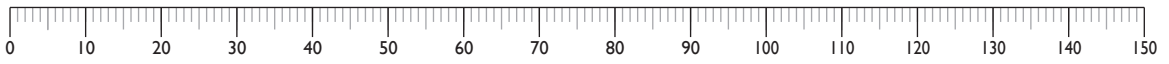

3.5mm ASYM® Plates

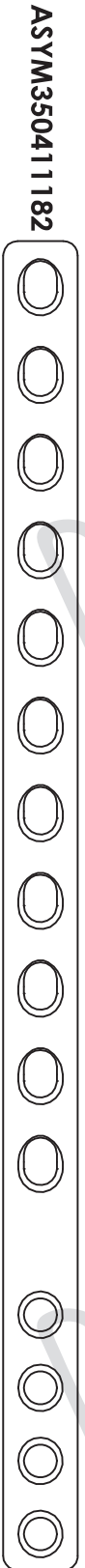
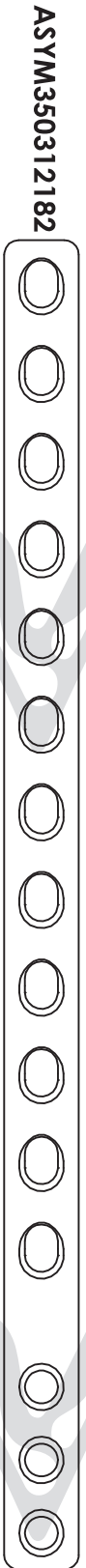
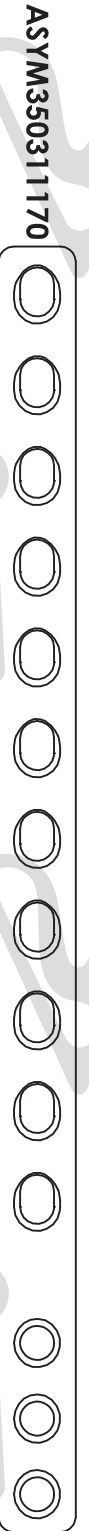
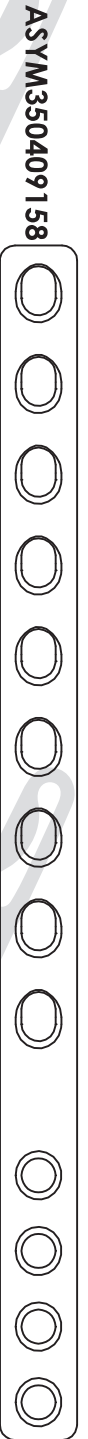
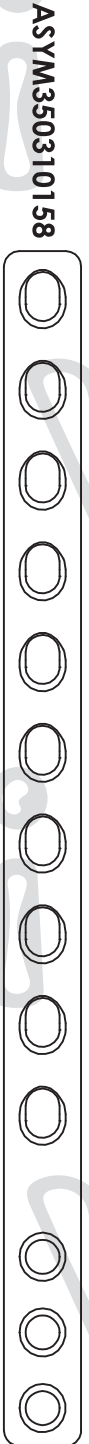
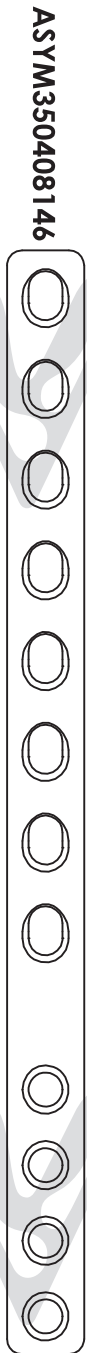
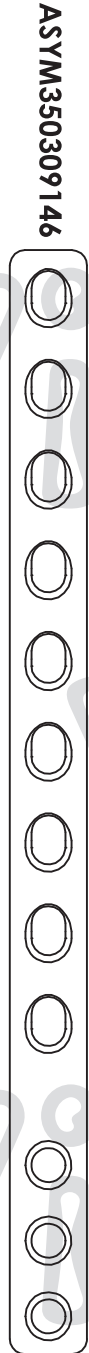

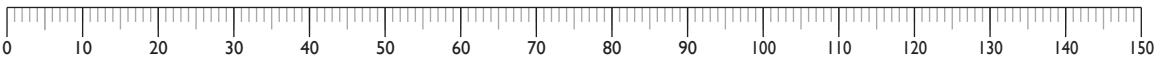

3.5mm Broad Compression Plates

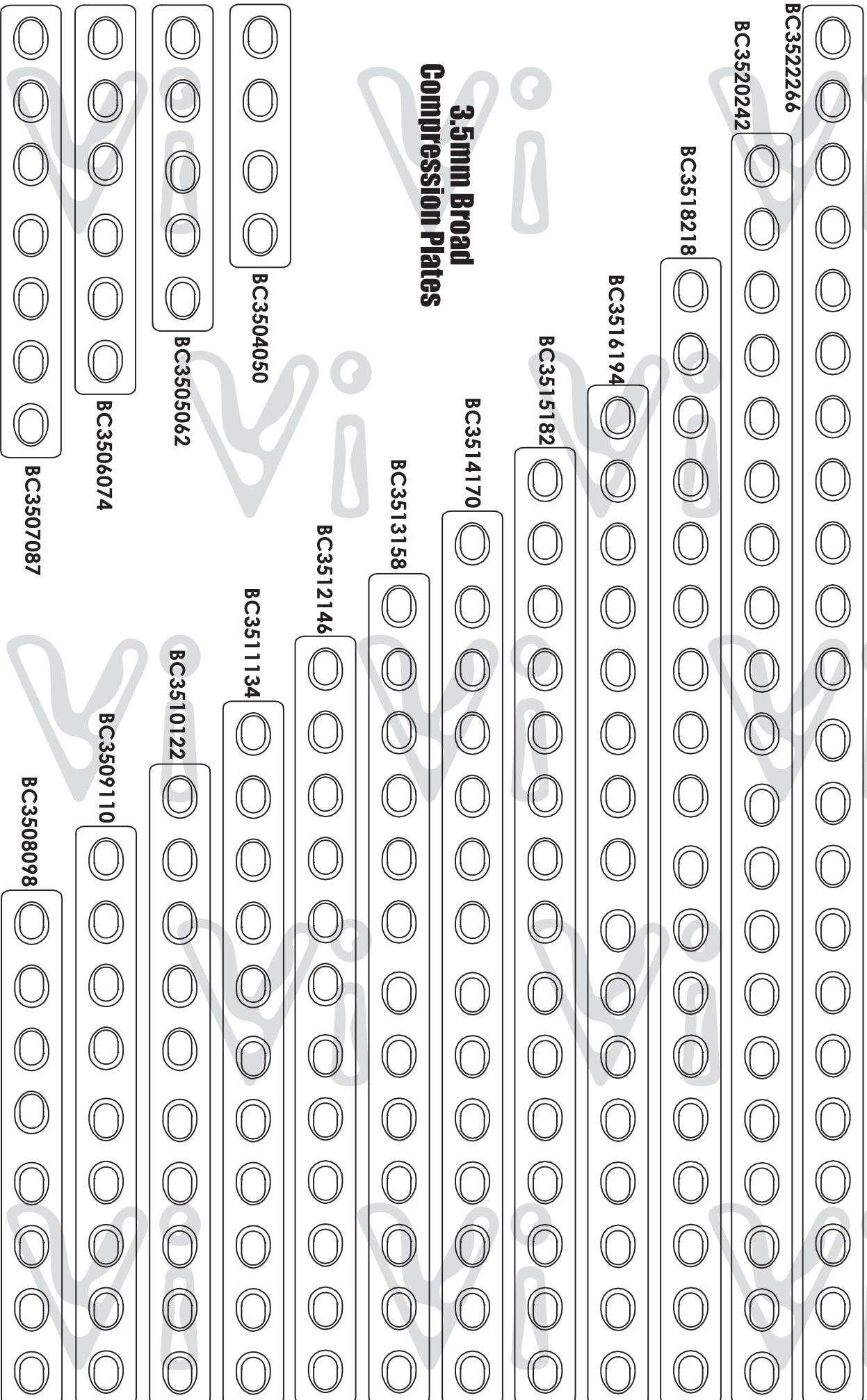

PLEASE NOTE THAT PLATE PROFILES ARE ACTUAL SIZE YOU WILL NEED TO COMPENSATE FOR X-RAY MAGNIFICATION • PROFILES FOR GUIDANCE ONLY PLATES MAY BE AMENDED AT ANY TIME

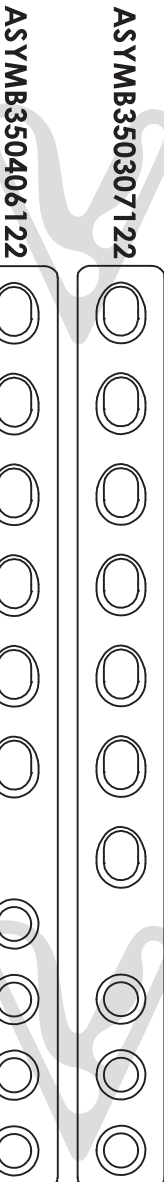
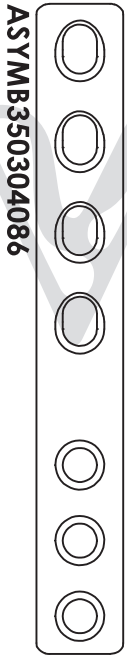
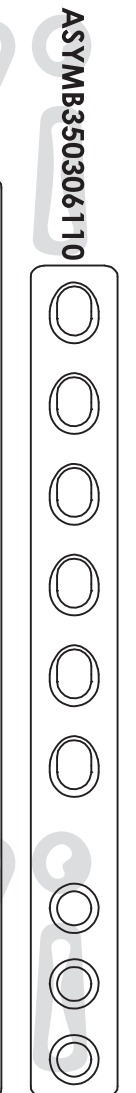
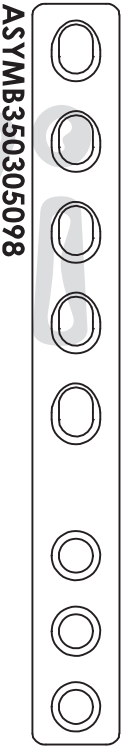
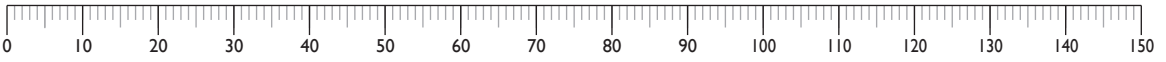

3.5mm Broad ASYM® Plates

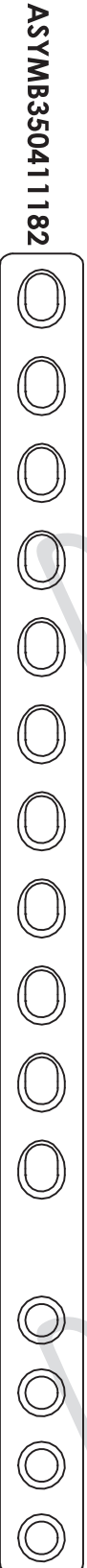
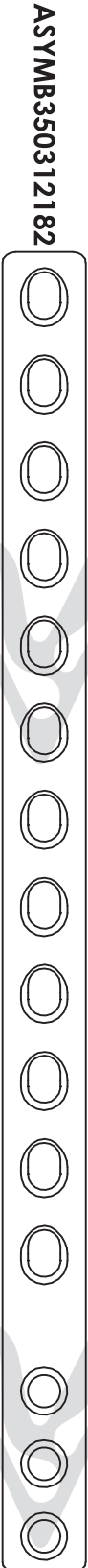
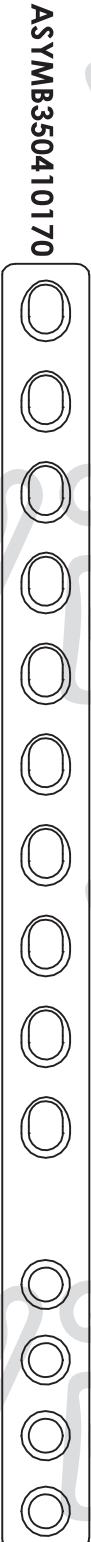
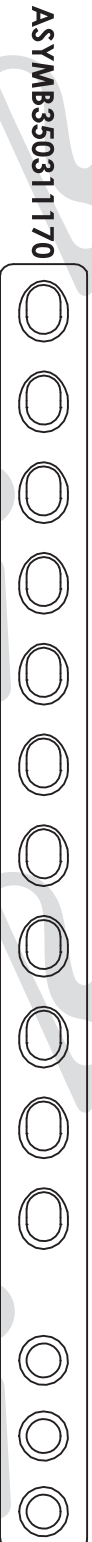
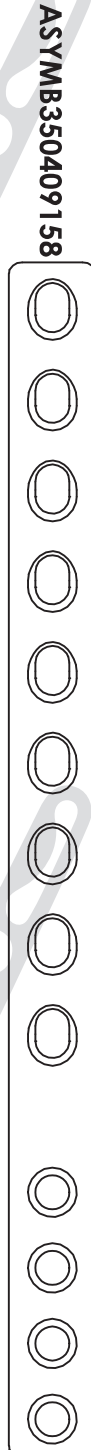
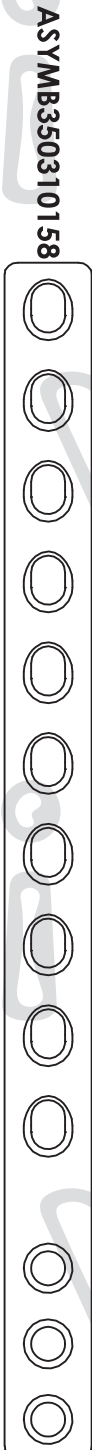
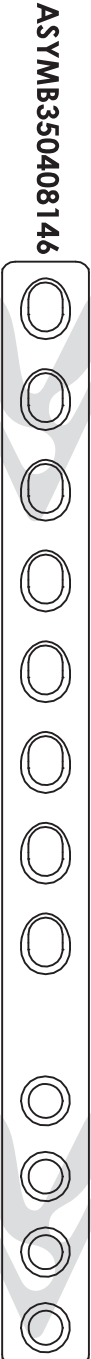
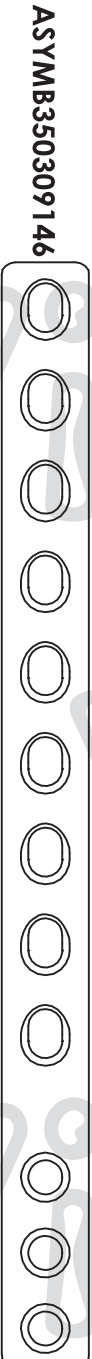
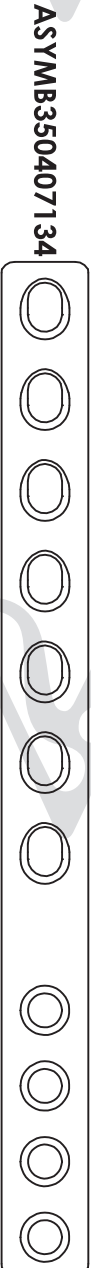
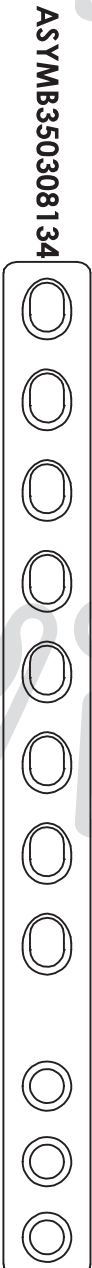

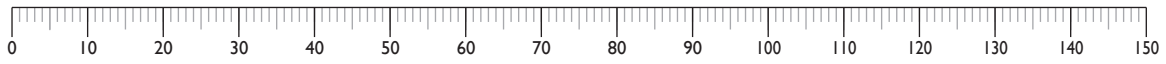

3.5mm Heavy Duty Round Hole Plates

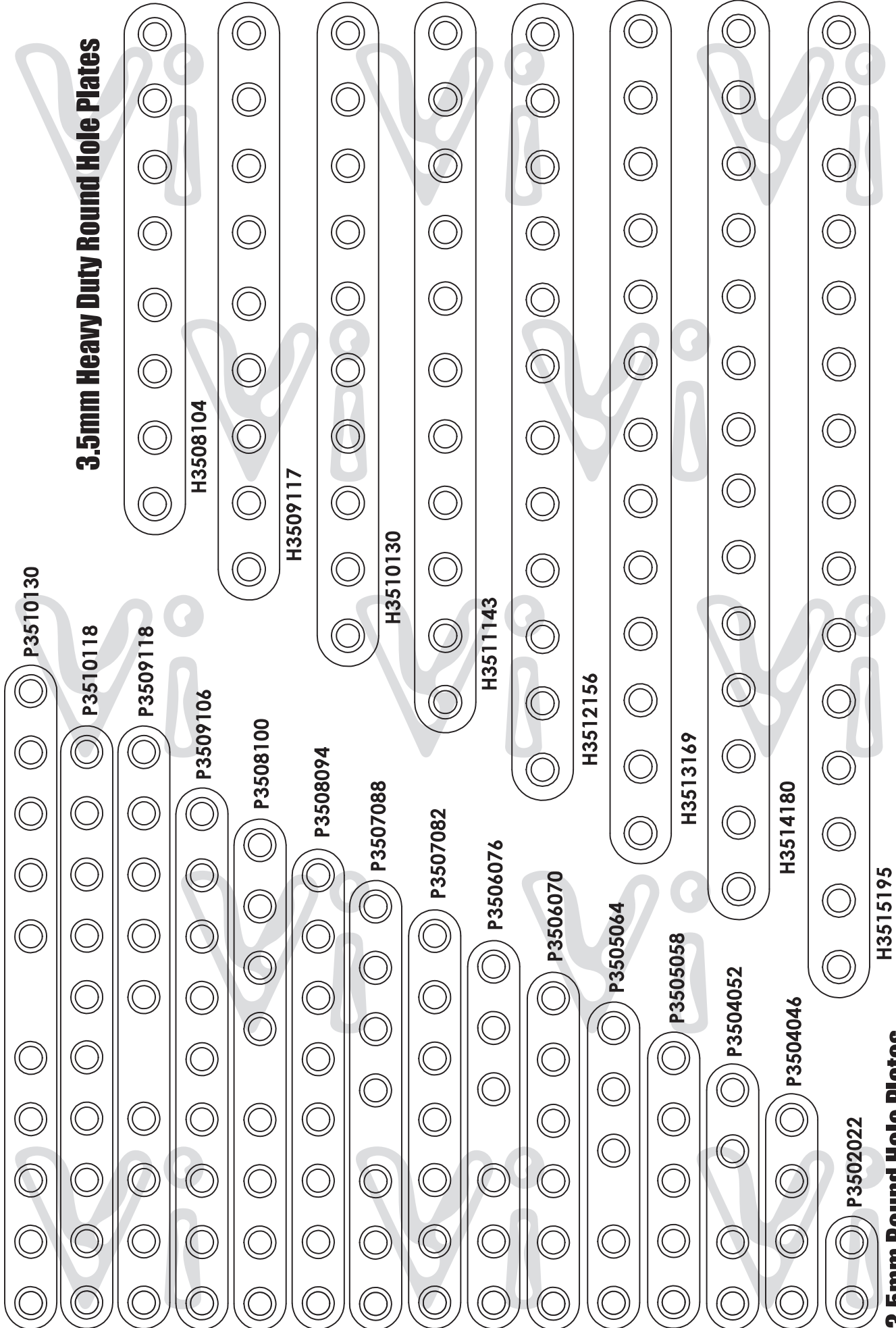

P3510130

P3510118

P3509118

P3509106

P3508100

P3508094

P3507088

P3507082

P3506076

P3506070

P3505064

P3505058

P3504052

P3504046

P3502022

H3508104

H3509117

H3510130

H3511143

H3512156

H3513169

H3514180

H3515195

3.5mm Round Hole Plates

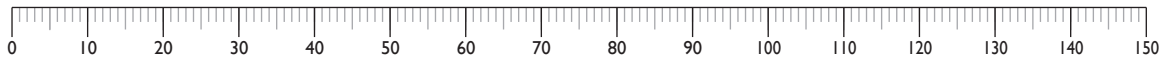

BHP3507120

3.5mm Biological Healing Plates



BHP3507130



BHP3508130



BHP3507142



BHP3508142



BHP3508154



BHPB3507130

3.5mm Broad Biological Healing Plates



BHPB3508130



BHPB3507142

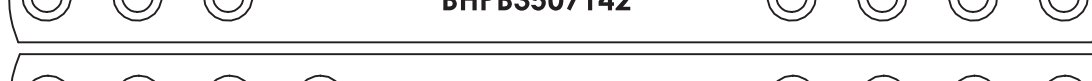

BHPB3508142



BHPB3508154



LC3503043

**3.5mm LC plates also available in 14 and 16 hole.
3.5mm broad LC plates are available in
4-16 hole with the same hole spacing.**



LC3504056



LC3502030



LC3505069



LC3506082

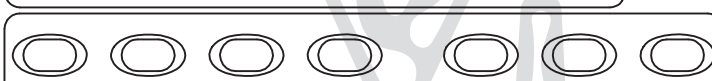

LC3507095



LC3508108

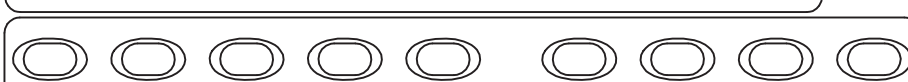

LC3509121

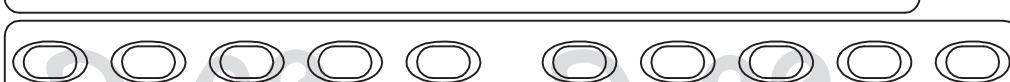

LC3510134



LC3512160

3.5mm IF Compression Plate



IF3507094

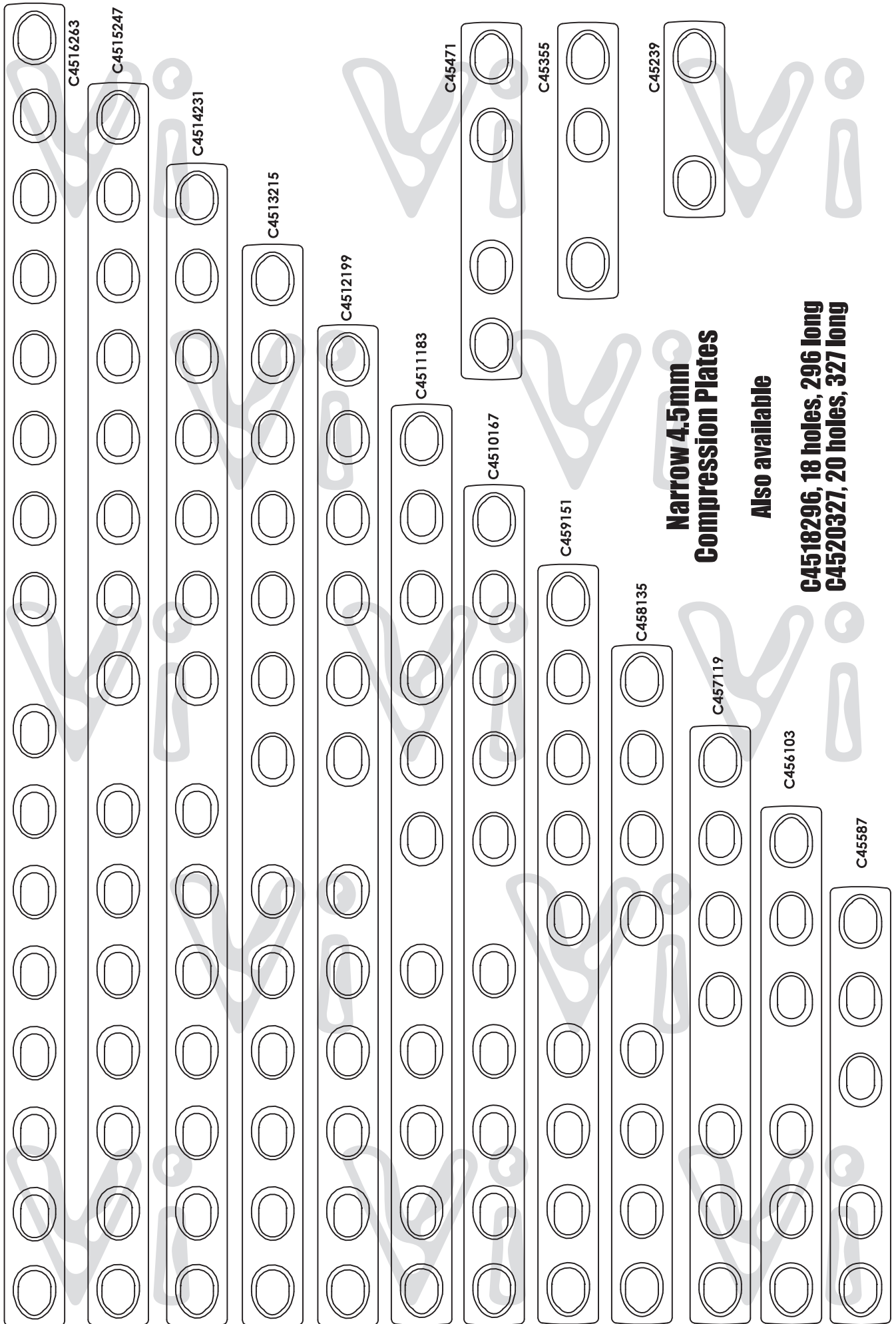
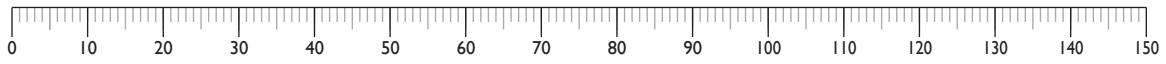

**Narrow 4.5mm
Compression Plates**

Also available

**C4518296, 18 holes, 296 long
C4520327, 20 holes, 327 long**

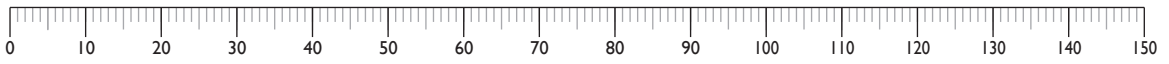

B4507119

B4508135

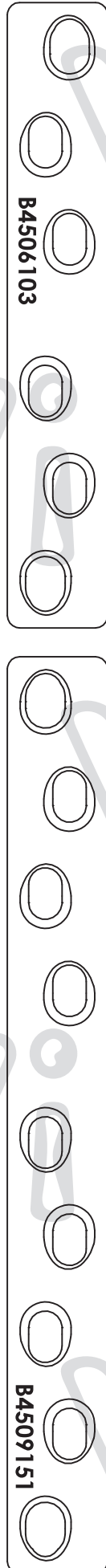

B4506103

B4509151

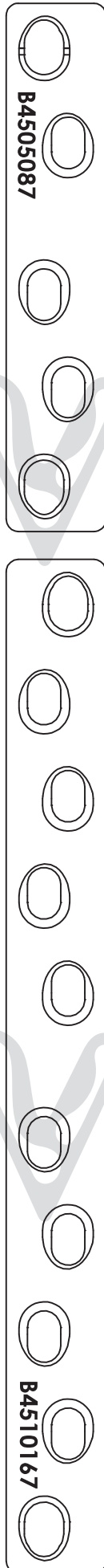

B4505087

B4510167

also available
B4517279, 17 holes, 279mm long
B4518295, 18 holes, 295mm long

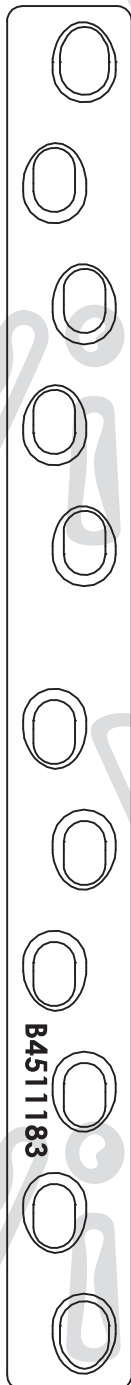

B4511183

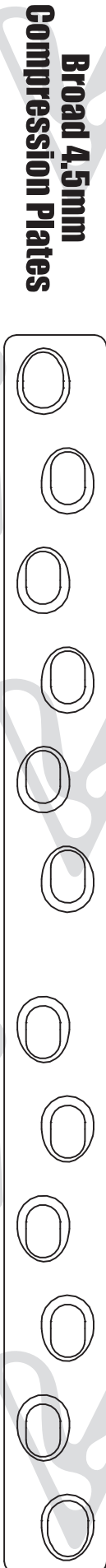

**Broad 4.5mm
Compression Plates**

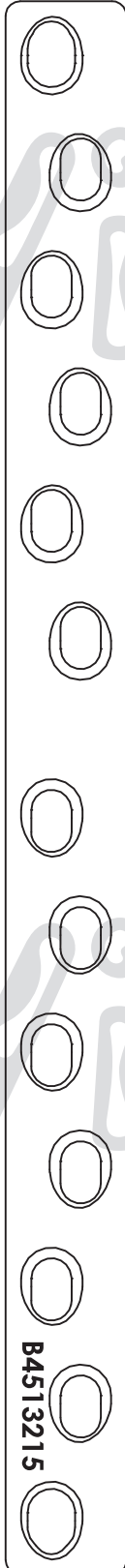

B4513215

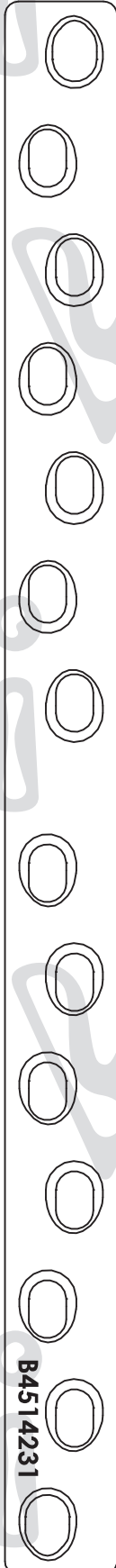

B4514231

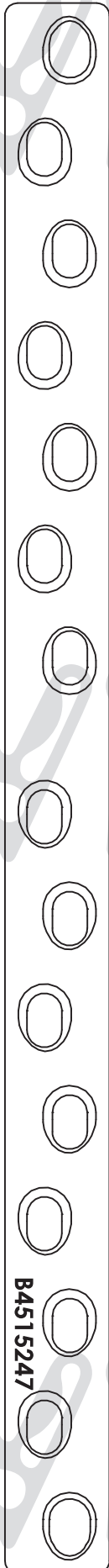

B4515247

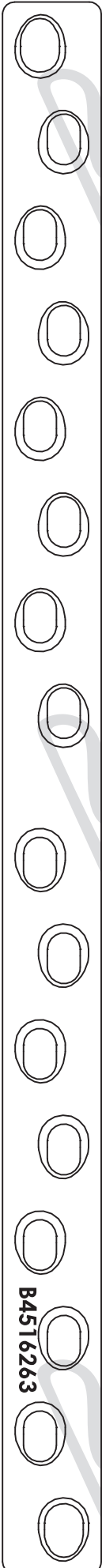

B4516263

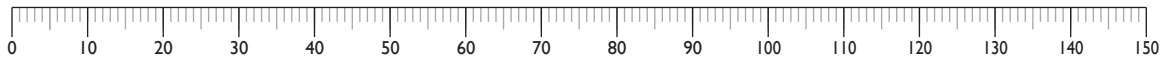

4.5mm Biological Healing Plates

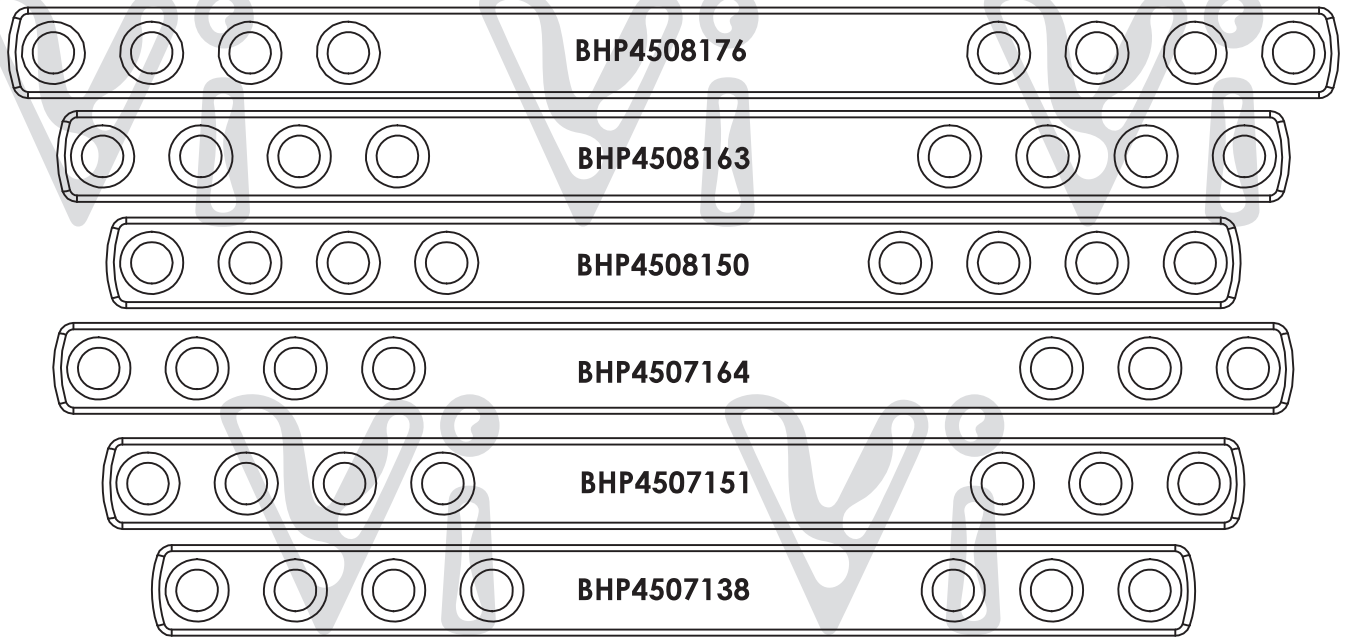

2.0mm Stacked Hole Locking Plates

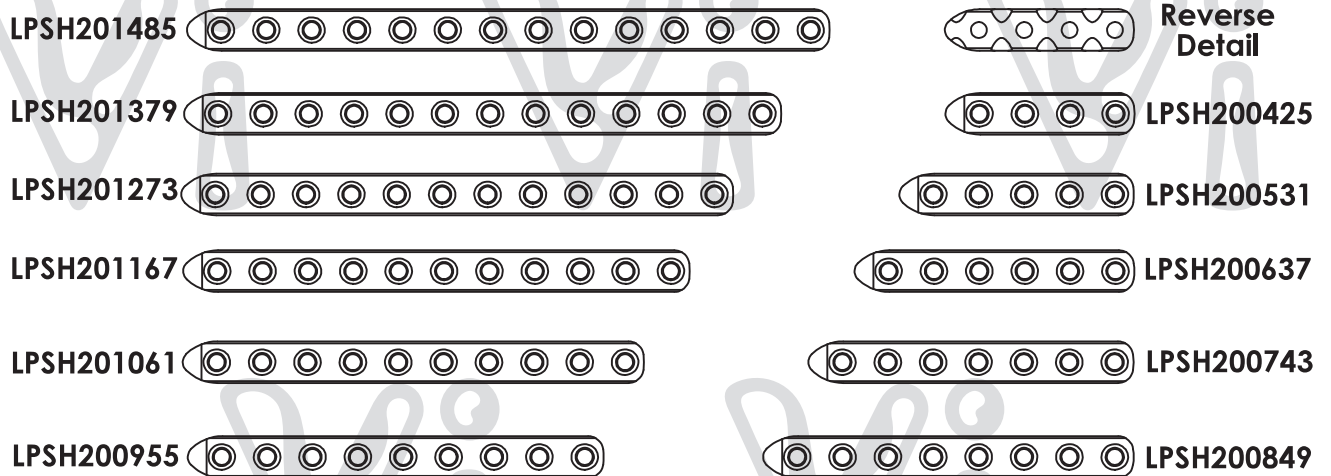

Cuttable Malleable Locking Plates

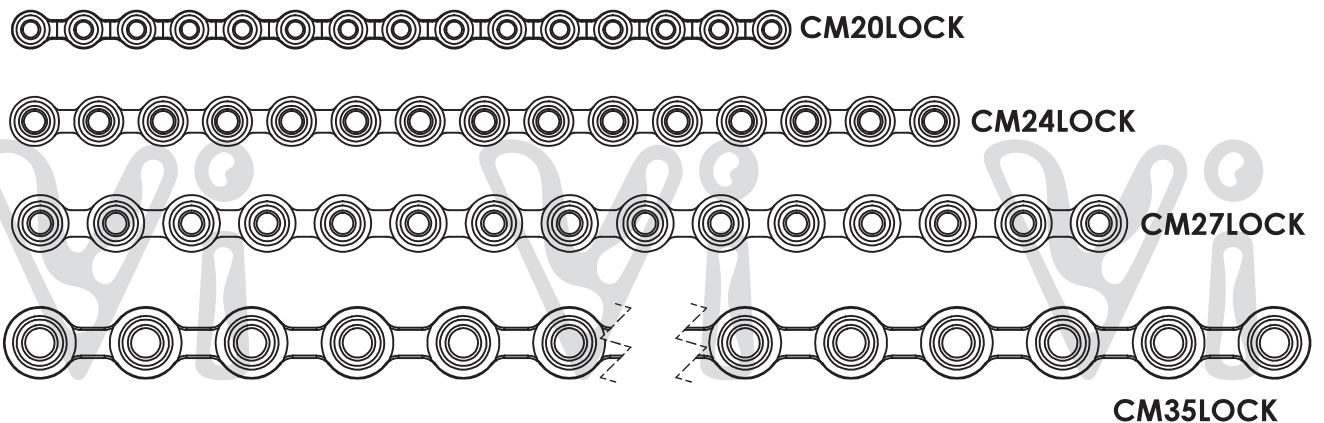

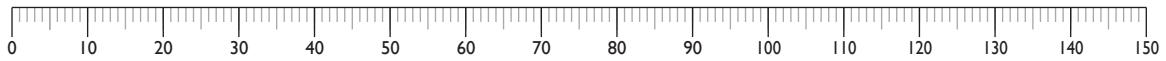

2.4mm Stacked Locking Hole Plates



LPSH2418129



LPSH2417122

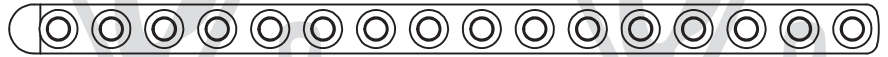

LPSH2416115



LPSH2415108



LPSH2414101



LPSH241394



LPSH241287



LPSH241180



LPSH241073



LPSH240431



LPSH240538



LPSH240645



LPSH240752



LPSH240859



LPSH240966



LPSH2718146



LPSH2717138



LPSH2716130



LPSH2715122



LPSH2714114



LPSH2713106



LPSH271298



LPSH271190



LPSH271082



LPSH270974

LPSH2704034



LPSH270866

LPSH270542



LPSH270758

LPSH270650



2.7mm Stacked Locking Hole Plates

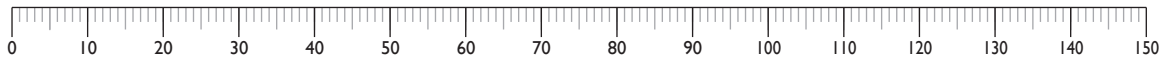

3.5mm Stacked Locking Hole Plates

LPSH3504046

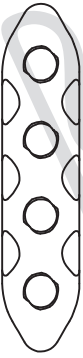

LPSH3505056



LPSH3506066



LPSH3506076



LPSH3507076



LPSH3508086

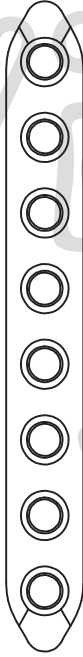

LPSH3509096



LPSH3510106



LPSH3511116



LPSH3518186

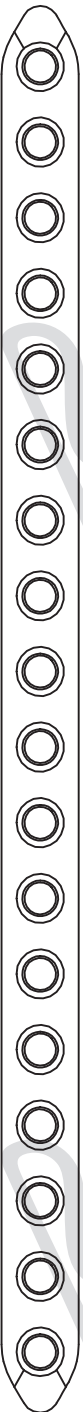

LPSH3517176



LPSH3516166



LPSH3515156



LPSH3514146

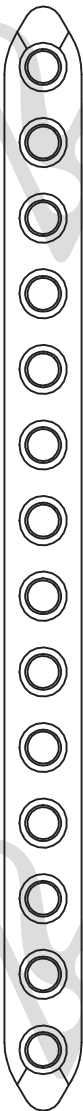

LPSH3513136



LPSH3508136



LPSH3508126



LPSH3512126

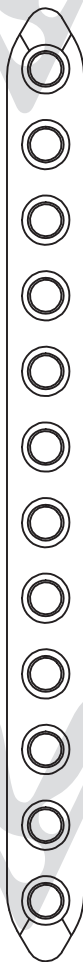

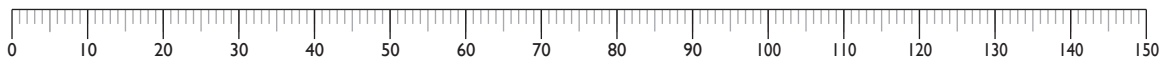

1.5mm Dynamic Locking Plates

2.0mm Dynamic Locking Plates

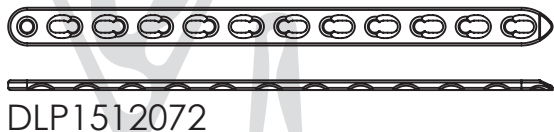

DLP1512072

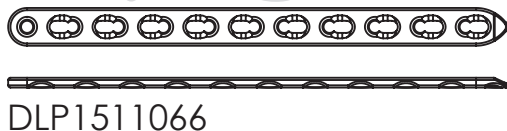

DLP1511066

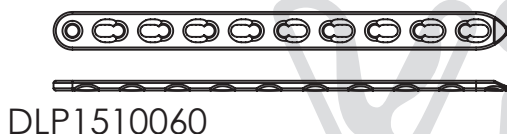

DLP1510060

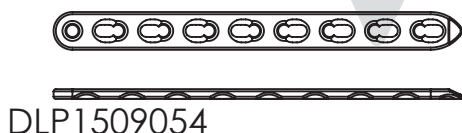

DLP1509054

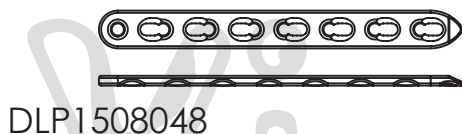

DLP1508048

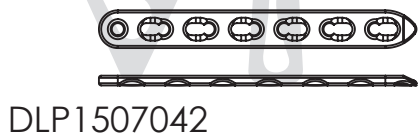

DLP1507042

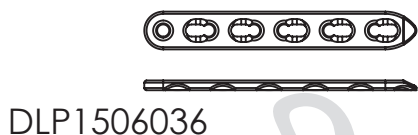

DLP1506036

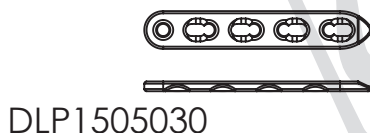

DLP1505030



DLP1504024

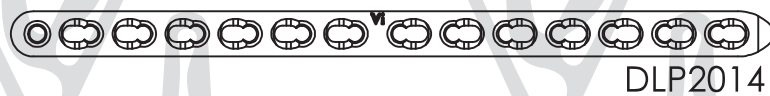

DLP2014101

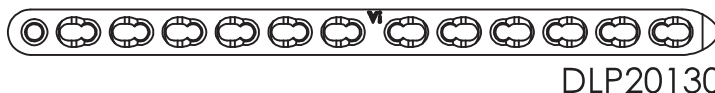

DLP2013094

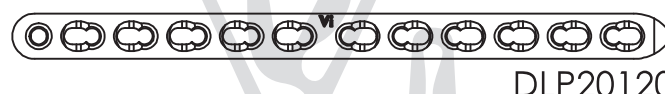

DLP2012087

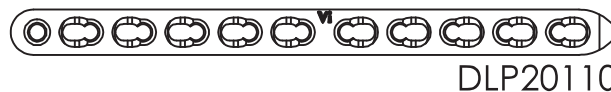

DLP2011080

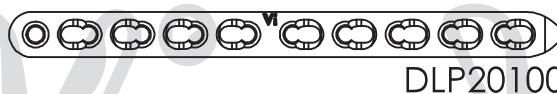

DLP2010073

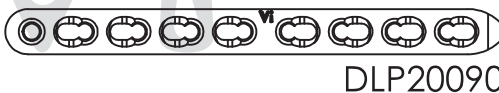

DLP2009066

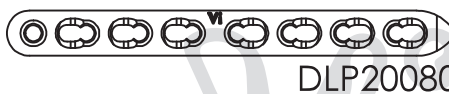

DLP2008059

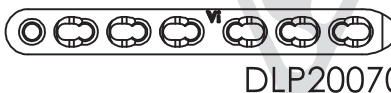

DLP2007052



DLP2006045



DLP2005038



DLP2004031

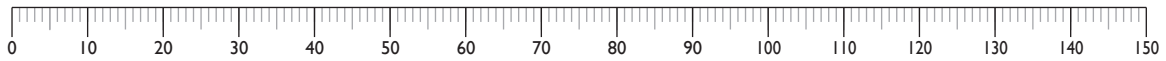

DLP2418164K



DLP2417155K



DLP2416146K



DLP2415137K



DLP2414128K



DLP2413119K

2.4mm Dynamic Locking Plates



DLP2412110K



DLP2411101K



DLP2404038N



DLP2410092K or ...N



DLP2405047N



DLP2409083K or ...N



DLP2406056K or ...N



DLP2408074K or ...N



DLP2407065K or ...N



DLP2718164



DLP2717155



DLP2716146



DLP2715137



DLP2714128



DLP2713119



DLP2712110



DLP27111101



DLP2710092



DLP2709083



DLP2708074



DLP2704038



DLP2705047



DLP2706056



DLP2707065



**2.7mm Dynamic
Locking Plates**

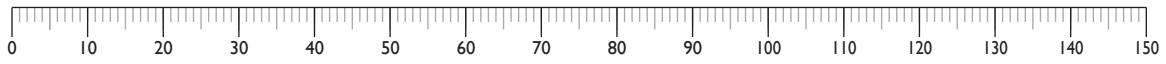

3.5mm Dynamic Locking Plates



DLP3518237



DLP3517224



DLP3516211



DLP3515198



DLP3514185



DLP3513172



DLP3512159



DLP3511146



DLP3510133



DLP3509120



DLP3504055



DLP3505068



DLP3506081



DLP3507094



DLP3508107

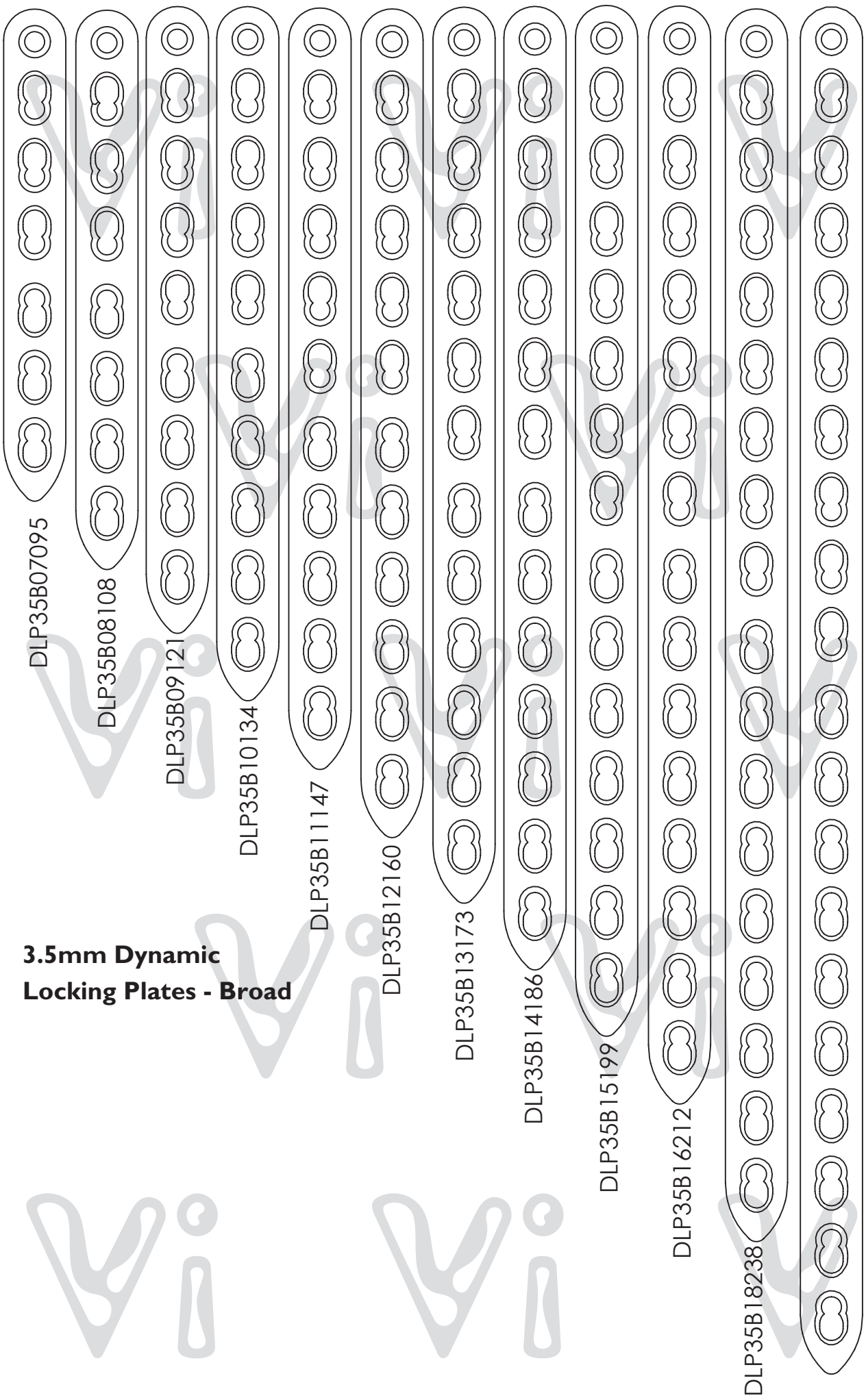
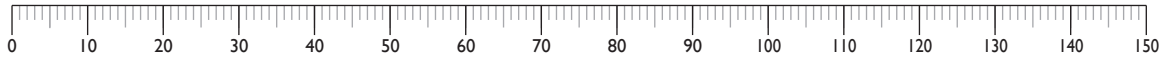

DLP35B07095

DLP35B08108

DLP35B09121

DLP35B10134

DLP35B11147

DLP35B12160

DLP35B13173

DLP35B14186

DLP35B15199

DLP35B16212

DLP35B18238

DLP35B20264

3.5mm Dynamic Locking Plates - Broad

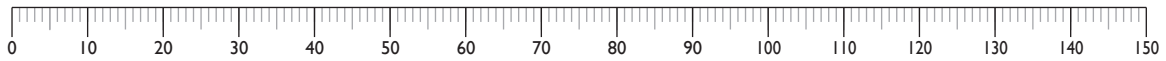

Cuttable Plate Range

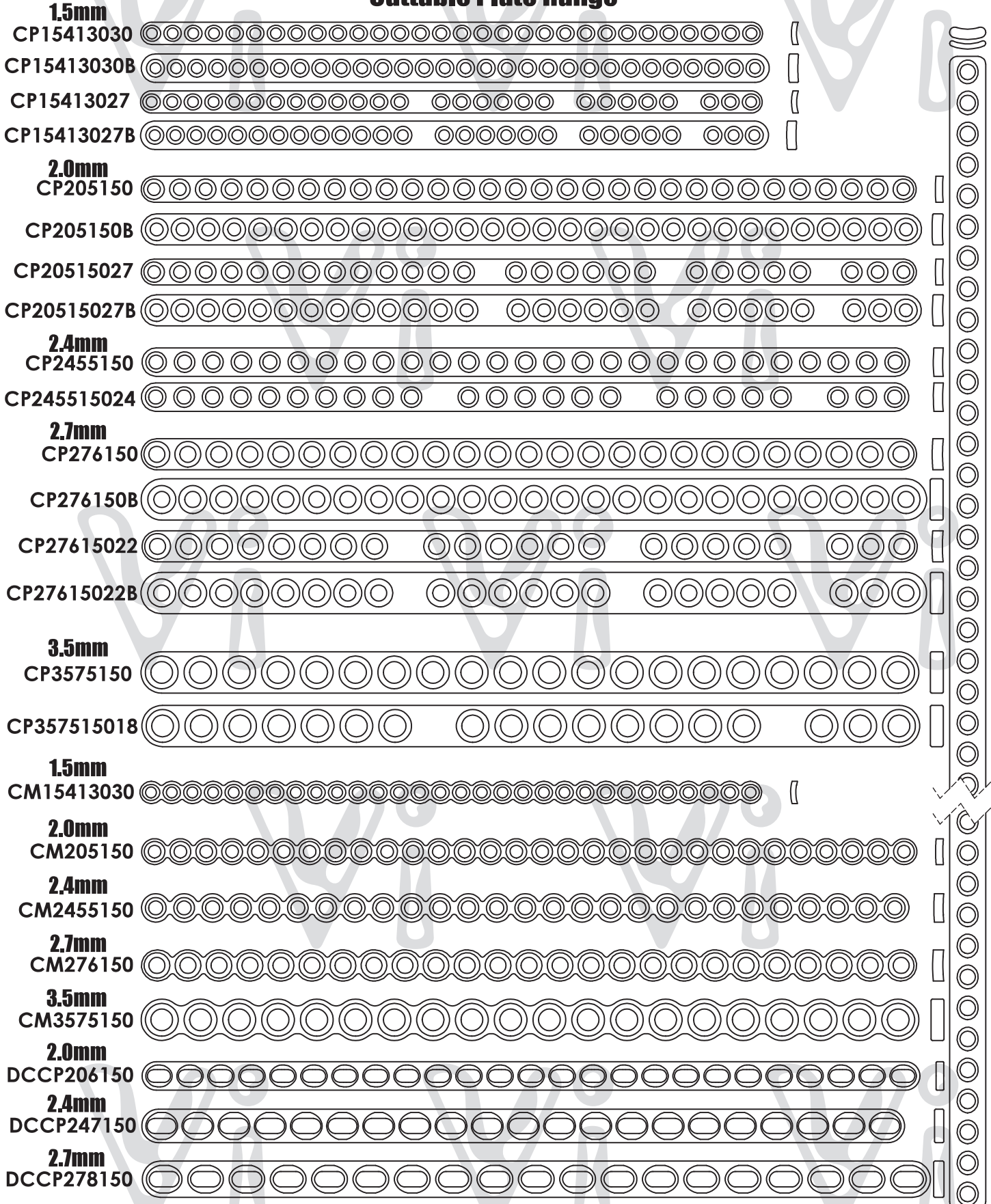

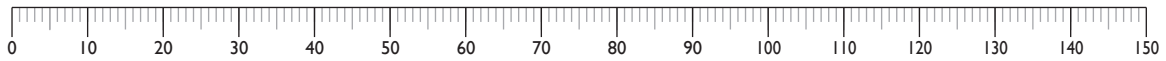

1.5mm T-Plates

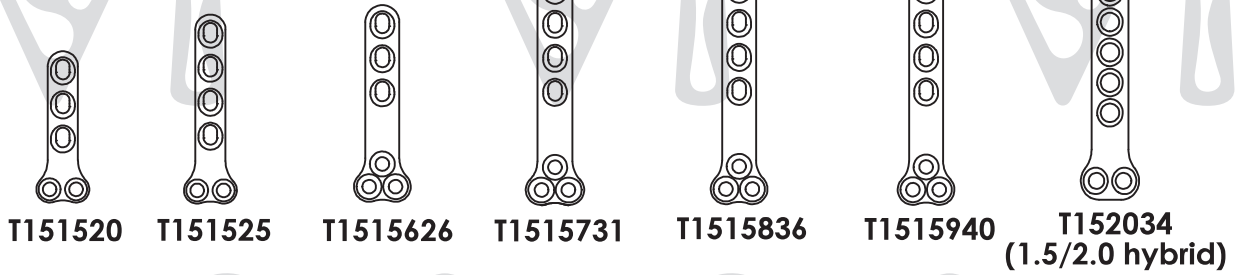

2.0mm T-Plates

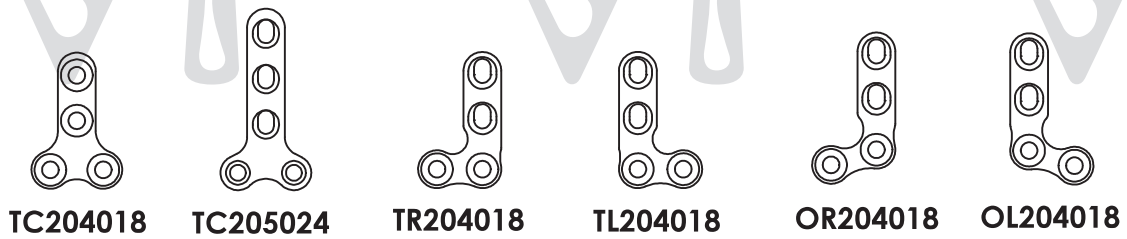
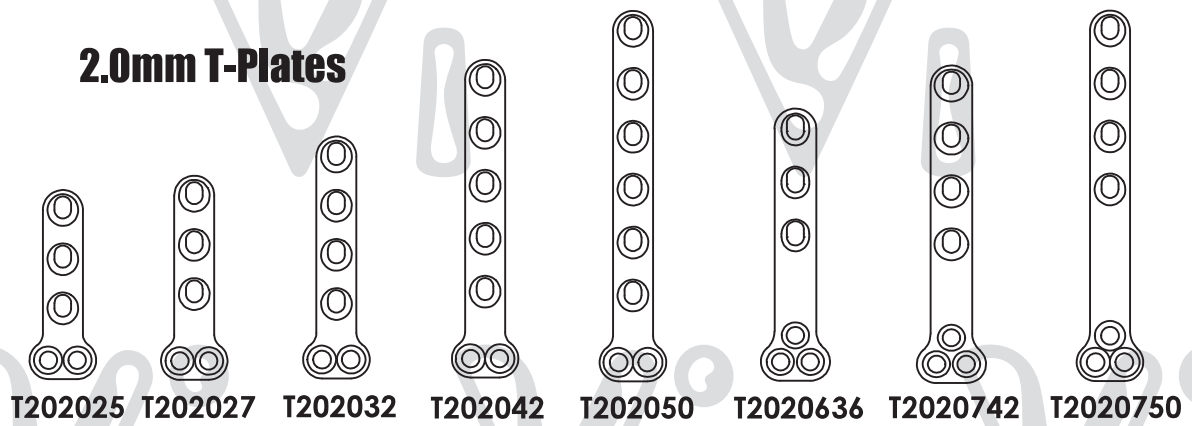

2.0/2.4/2.7mm Hybrid T-Plates

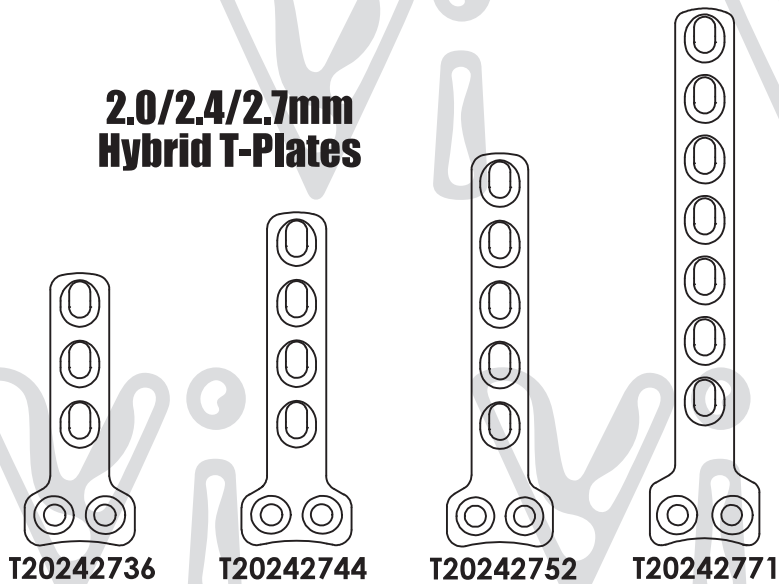

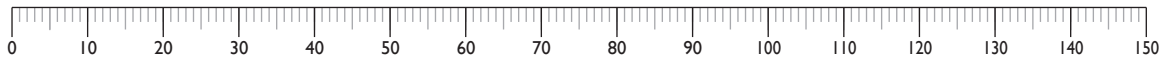

T241072



T270535

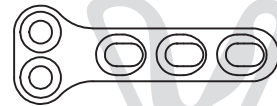

T241172



T270643

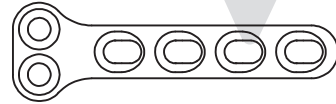

T240858



T240958



T270749

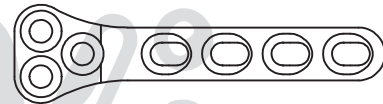

T240853

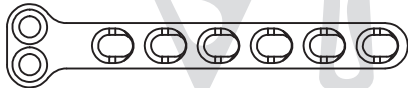

T270857

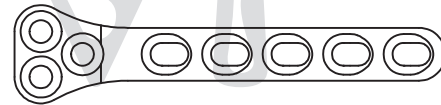

T240744



T270967

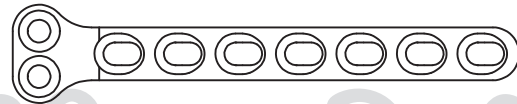

T240638



T270973

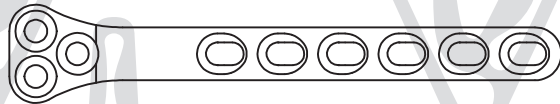

T240531



T271073

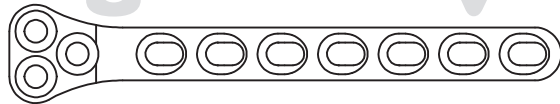

T271191

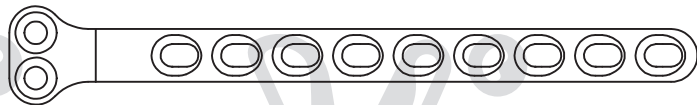

T271291

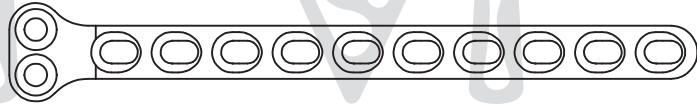

T271297

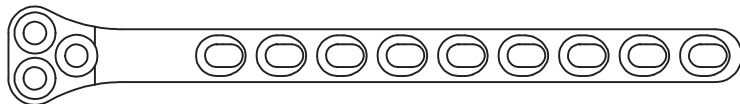

T271397

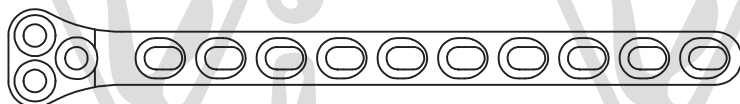

2.4mm and 2.7mm T-Plates

Tapered profile

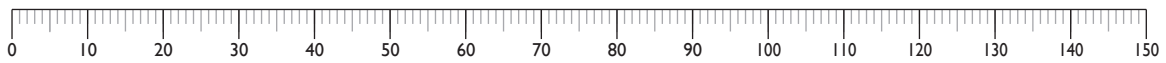

2.7mm T-Plates

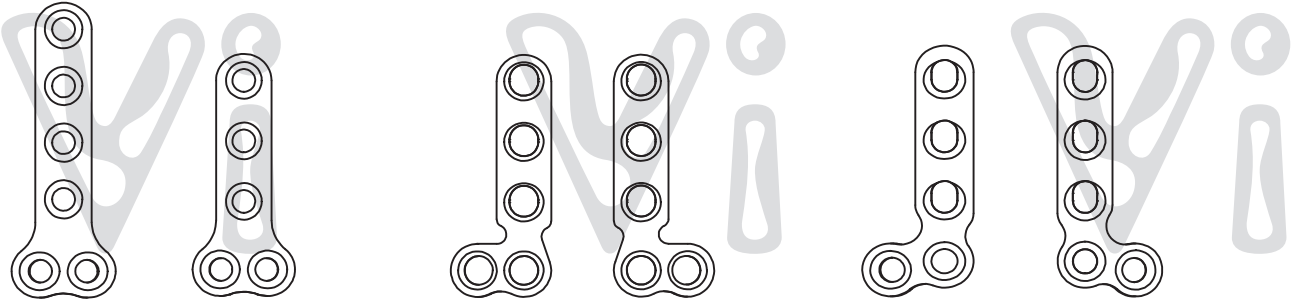

TC270639 TC270532

TR270532 TL270532

OR270532 OL270532

3.5mm T-Plates

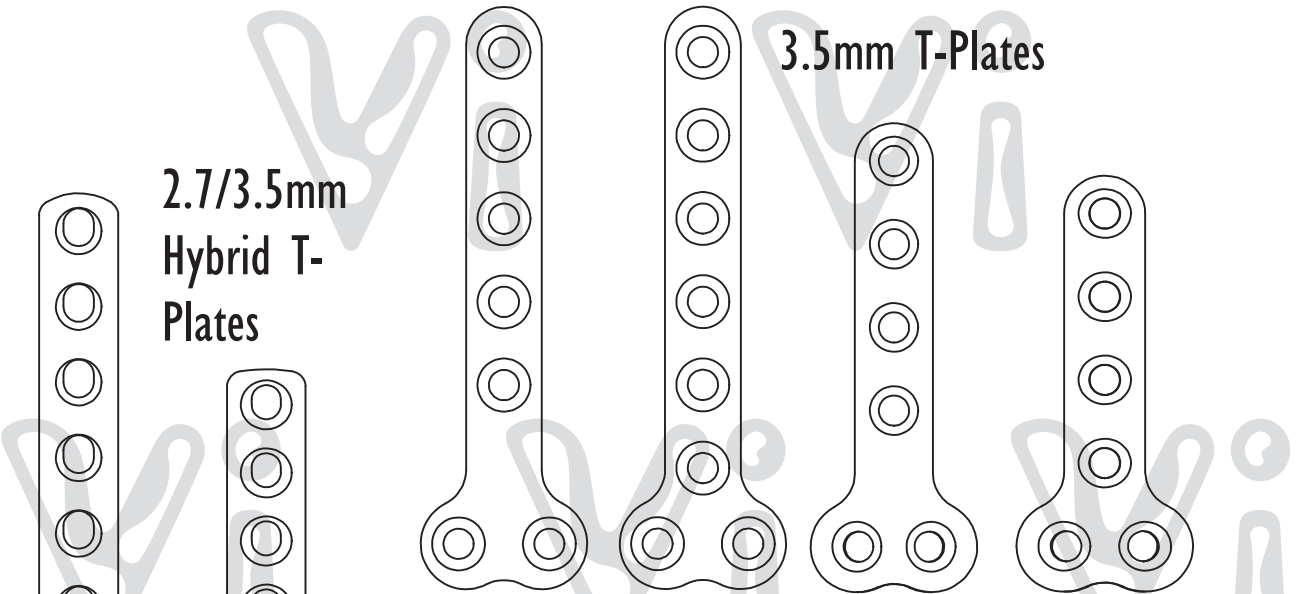

2.7/3.5mm Hybrid T- Plates

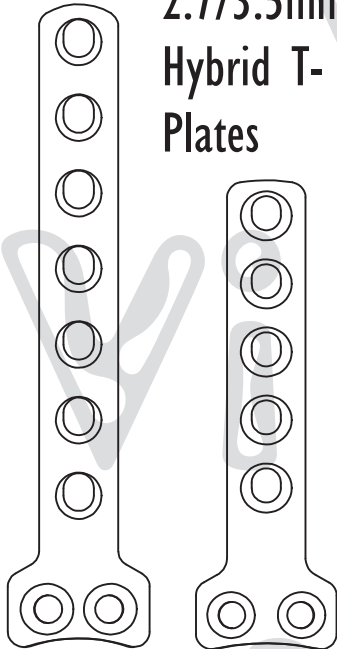

T273585

T273562

TC350777

TC350877

TC350662

TC350655

Hybrid Anatomical T-Plates

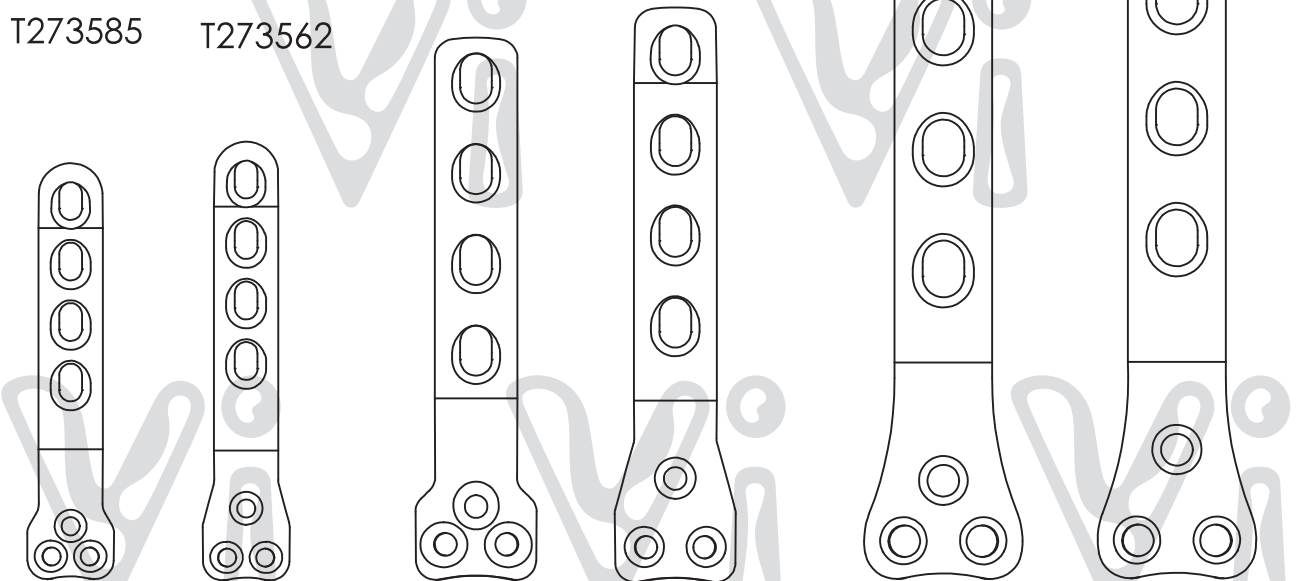

T2027755 T2027758

T273572 T273576

T3545795

T3545799

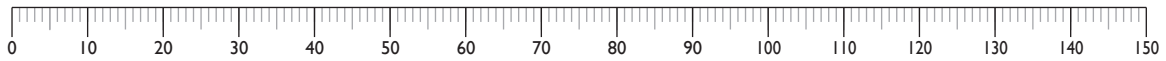

2.0mm Locking T-Plates



T2020850LOCK



T2020632LOCK



T2020532LOCK

2.4/2.7mm Locking T-Plates



T2427755LOCK

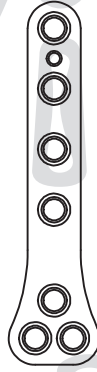

T2427748LOCK

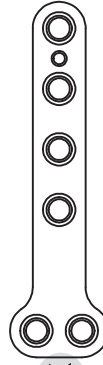

T2427647LOCK

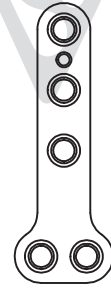

T2427537LOCK

3.5mm Locking T-Plates

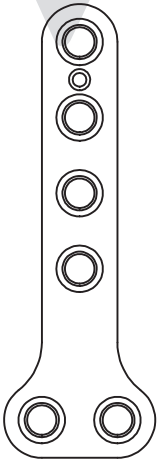

T350660LOCK

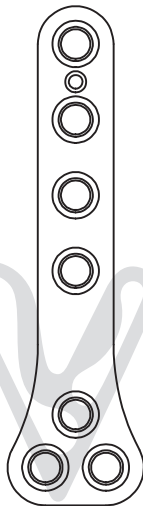

T350766LOCK

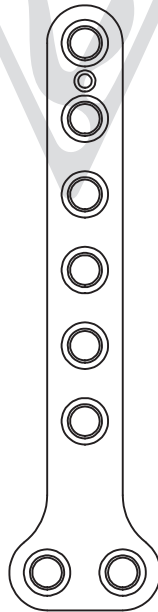

T350880LOCK

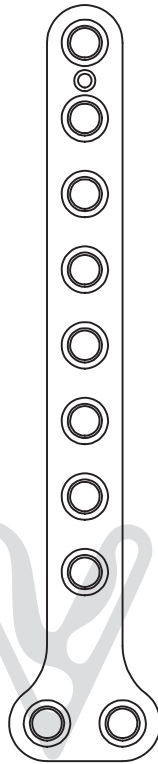

T3510100LOCK

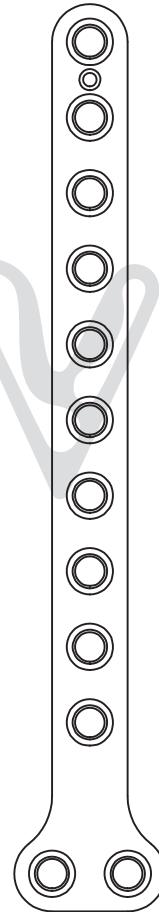

T3512120LOCK

LokRod™ Plates

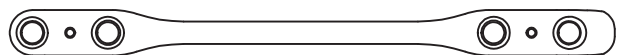

LRP24270480

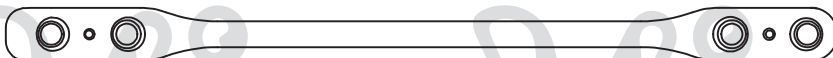

LRP242704110

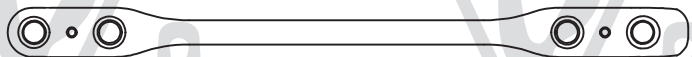

LRP24270490

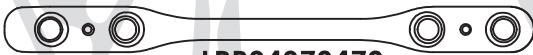

LRP24270470

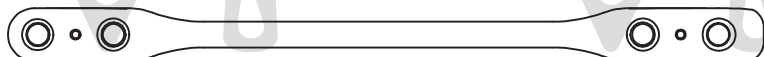

LRP242704100



Butterfly Plates

1.5mm



BTFP15414



BTFP15415



BTFP15619

2.0mm



BTFP20416



BTFP20417



BTFP20623

2.4mm



BTFP24418



BTFP24420

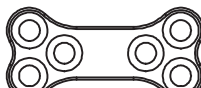

BTFP24626

2.7mm



BTFP27421



BTFP27425

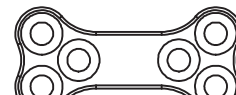

BTFP27630

TPO Plates



090179

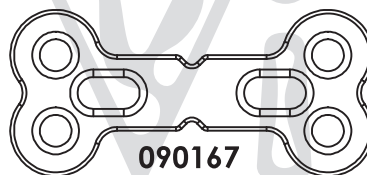

090167

Acetabular Plates



AP200400xs (2.0)



AP200401L (2.0)



AP270603 (2.7)



AP350605 (3.5)



AP200400 (2.0)



AP240406 (2.4)

Contoured in 3 Dimensions



AP200401 (2.0)



AP270602 (2.7)



AP350604 (3.5)

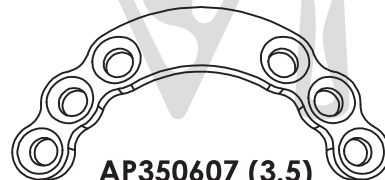

AP350607 (3.5)

2.7mm

Reconstruction Plates

3.5mm

RC270756, RC270972, RC271188. Also available but not shown. RC3509106, RC3511130



RC271296



RC271080



RC270864



RC270648



RC270540

RC350558



RC350670



RC350782



RC350894



RC3510118



RC3512142



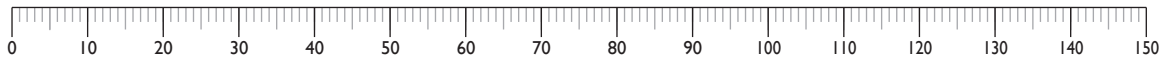

1.0mm Series

 C100210

 C100314

 C100418

 C100522

 C100626

 C100730

 C100834

 C100938

 C101042

 CM10390

 CP10390

 CP1039027

 CP10491

 CP1049120

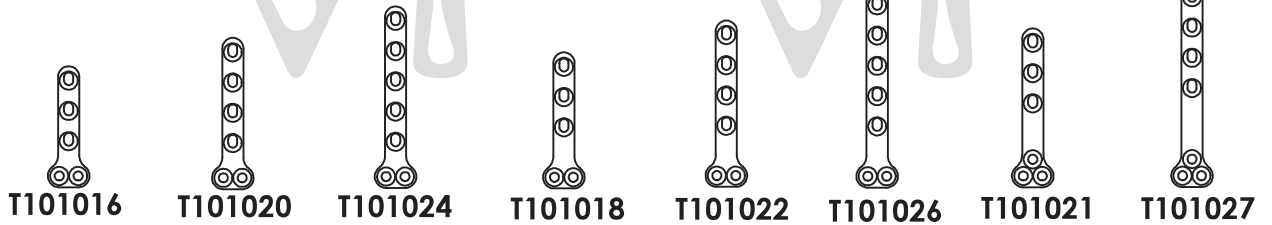

Partial Tarsal Arthrodesis

152925 (2.7/3.5)



152921 (2.7/3.5)



152922 (2.7/2.7)



152920 (2.0/2.7)



152920SC
(2.0/2.7)



152923 (2.0/2.0)



152924 (1.5/2.0)



**Elbow
Arthrodesis**

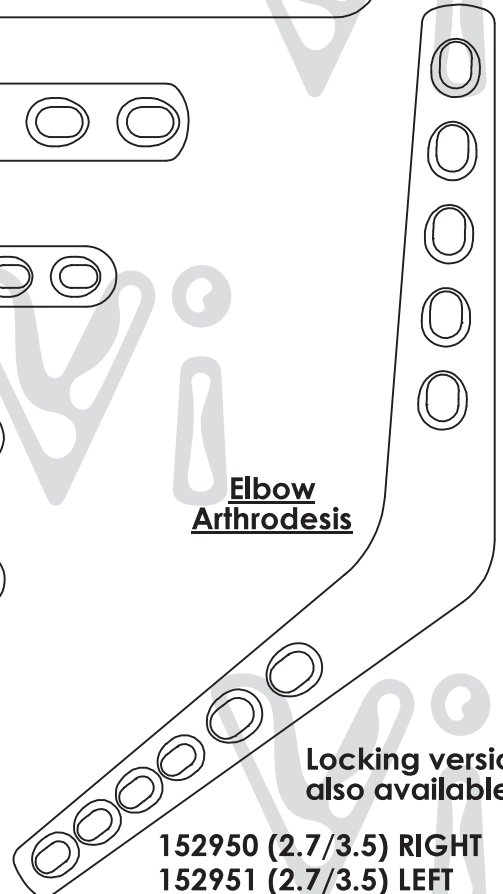

Locking version
also available.

152950 (2.7/3.5) RIGHT

152951 (2.7/3.5) LEFT

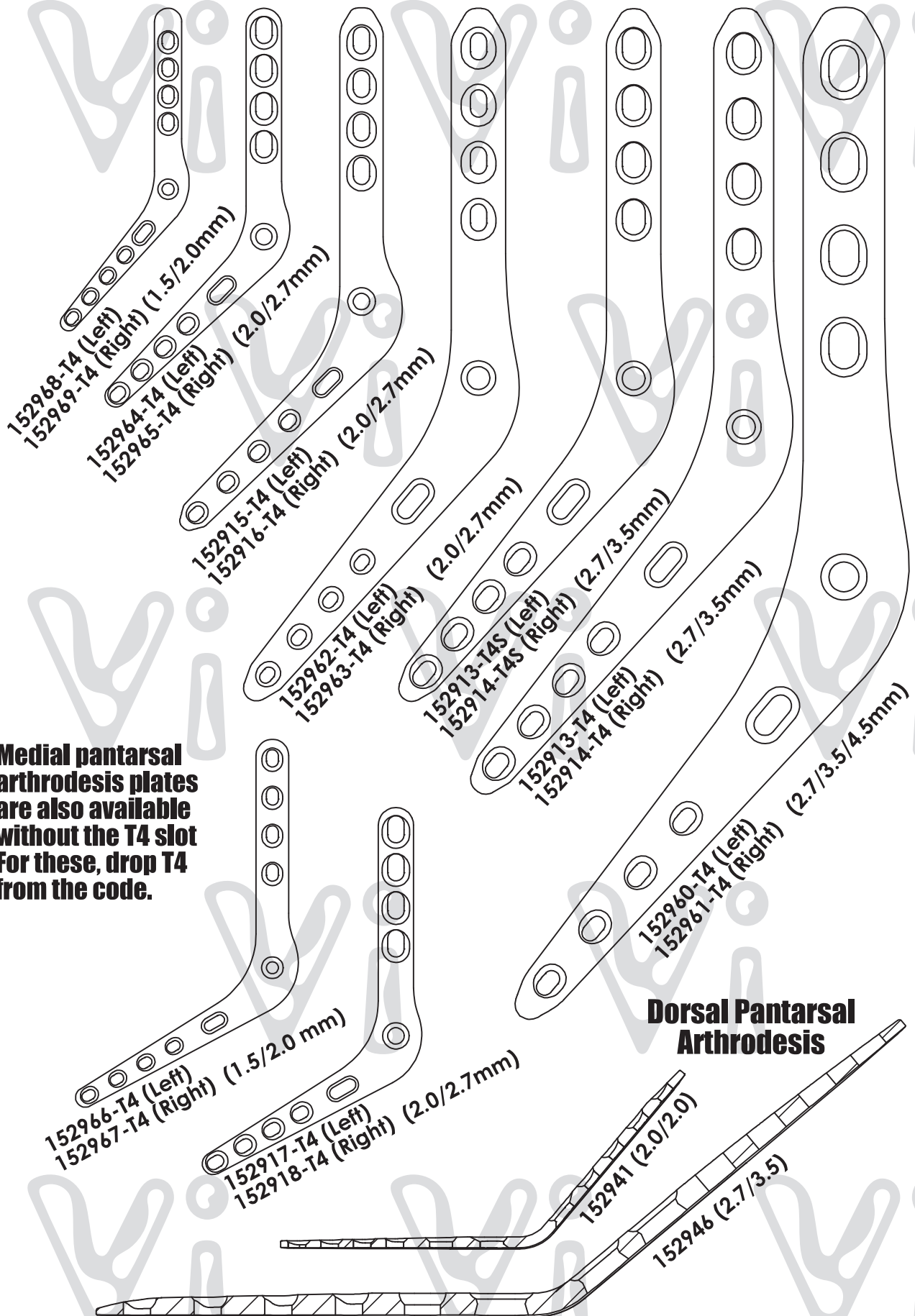
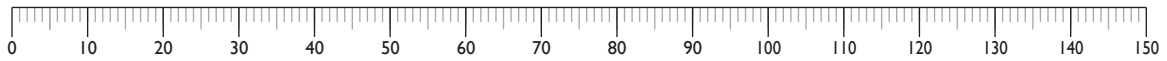

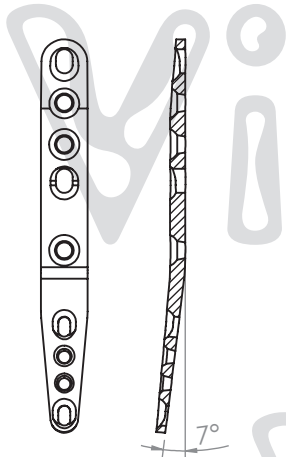
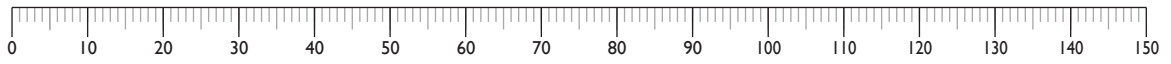

PCALK1520

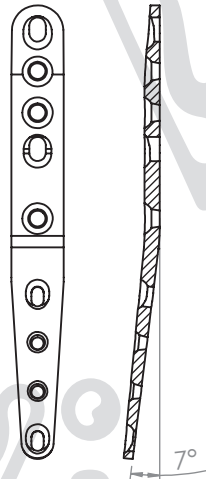

PCALK1520L

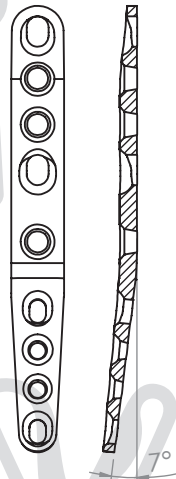

PCALK2024

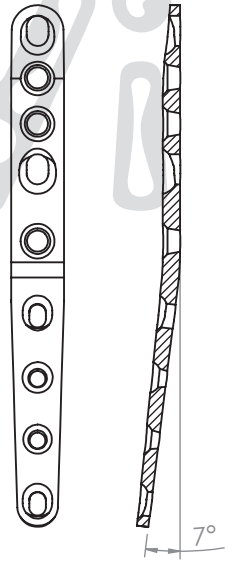

PCALK2024L

Pancarpal Arthrodesis Plates - Locking

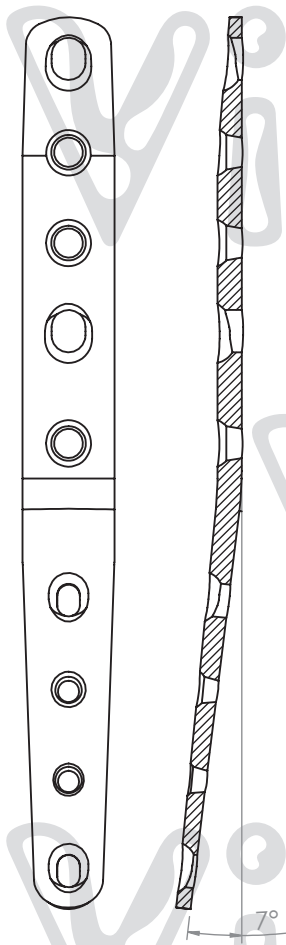

PCALK2735L

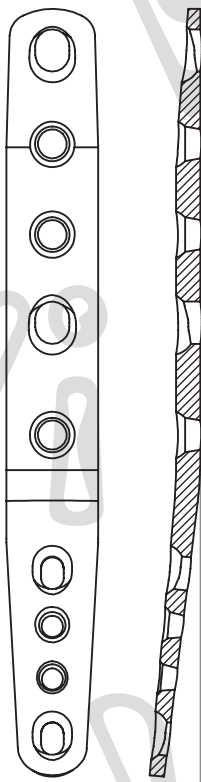

PCALK2735

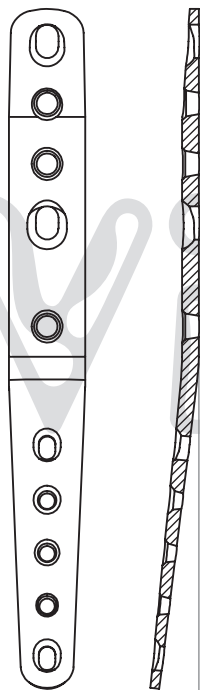

PCALK2027L

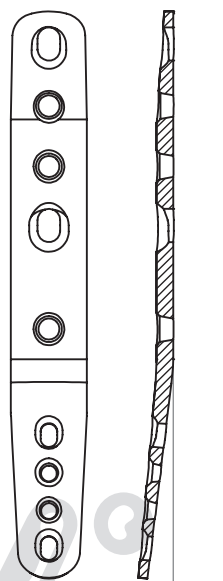

PCALK2027

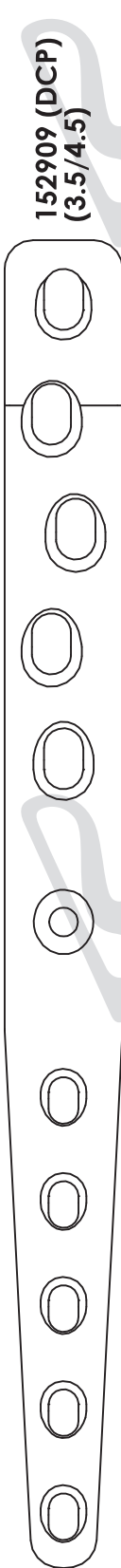
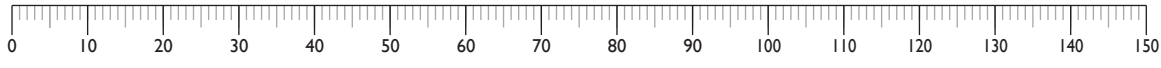

152909 (DCP)
(3.5/4.5)

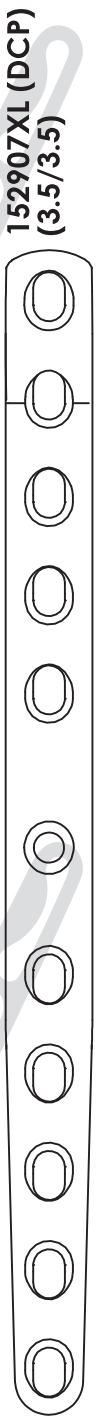

152907XL (DCP)
(3.5/3.5)

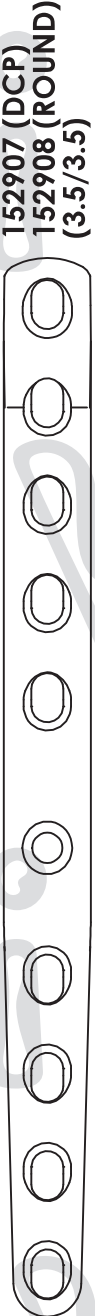

152907 (DCP)
152908 (ROUND)
(3.5/3.5)



152903 (DCP)
152904 (ROUND)
(2.7/3.5)

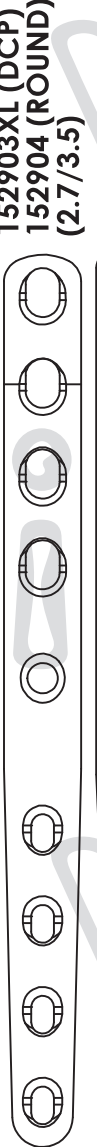

152903XL (DCP)
152904 (ROUND)
(2.7/3.5)

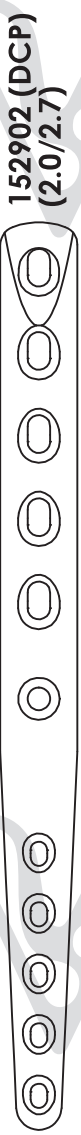

152902 (DCP)
(2.0/2.7)

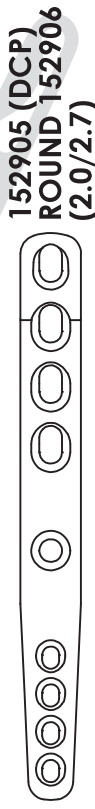

152905 (DCP)
ROUND 152906
(2.0/2.7)

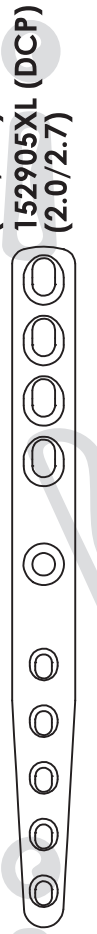

152905XL (DCP)
(2.0/2.7)



152912XL (DCP)
(2.0/2.0)



152911XL (DCP)
(1.5/2.0)



152912 (DCP)
(2.0/2.0)



152911 (DCP)
(1.5/2.0)



152970 (DCP)
(1.0/1.5)

Locking versions of select pancarpal arthrodesis plates are available.

Pancarpal Arthrodesis Plates

Partial Carpal Arthrodesis Plates

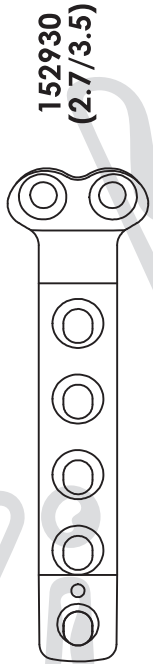

152930
(2.7/3.5)

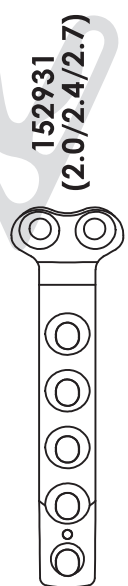

152931
(2.0/2.4/2.7)



152932
(1.5/2.0)

Feline Forelimb Salvage Plate

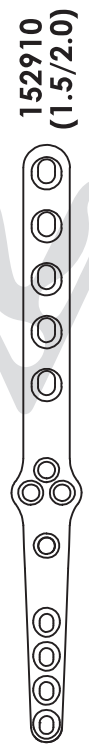

152910
(1.5/2.0)

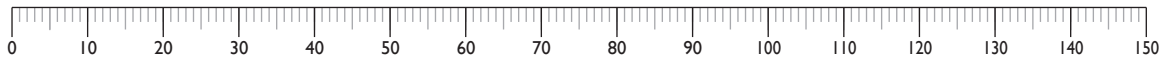

152980 (3.5 locking/2.7/3.5/4.5) NOTE: Scale 1:2



152903XXL (2.7/3.5) NOTE: Scale 1:2

Longer Plates

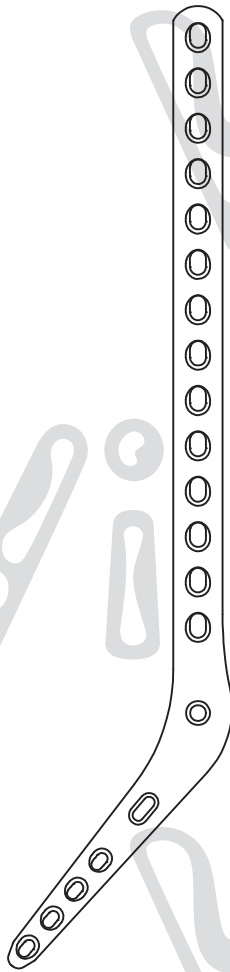

**152913-T4XL (Left)
152914-T4XL (Right)
2.7/3.5mm
NOTE: Scale:1:2**

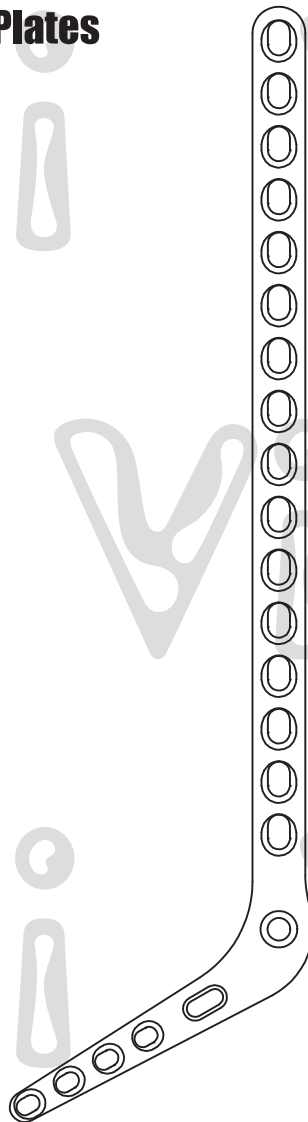

**152917-T4XL (Left)
152918-T4XL (Right)
2.0/2.7mm
NOTE: Scale 1:1**

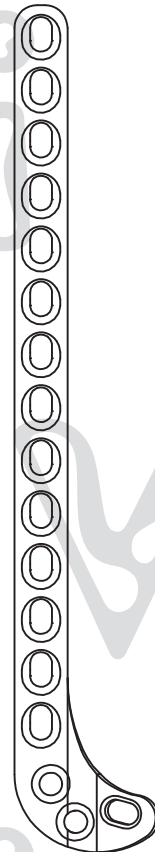

**152711L-XL (Left)
152711R-XL (Right)
2.4mm
NOTE: Scale 1:1**

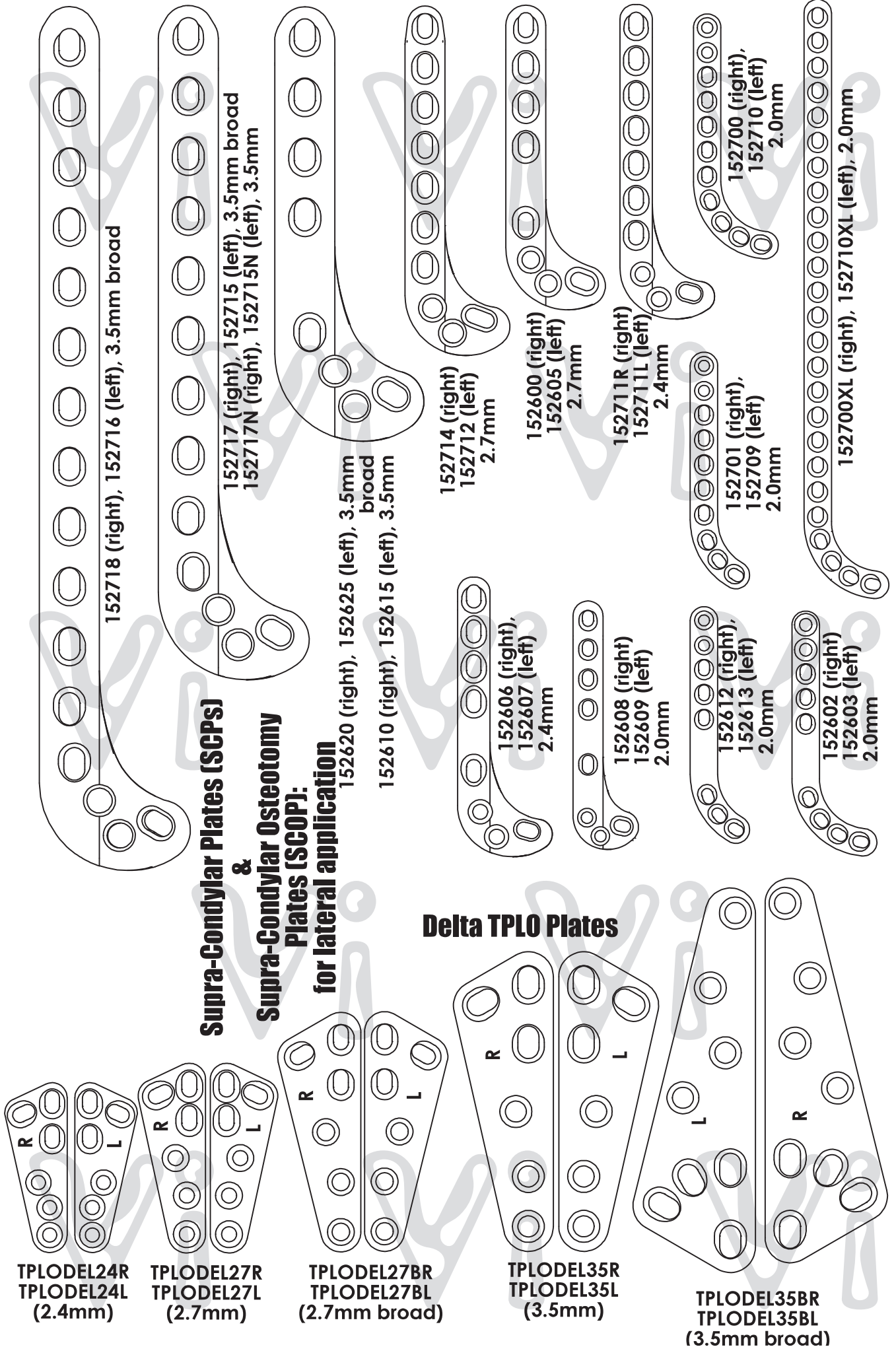
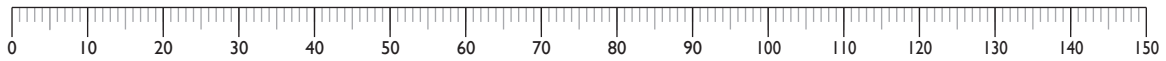

PLEASE NOTE THAT PLATE PROFILES ARE ACTUAL SIZE YOU WILL NEED TO COMPENSATE FOR X-RAY MAGNIFICATION • PROFILES FOR GUIDANCE ONLY PLATES MAY BE AMENDED AT ANY TIME

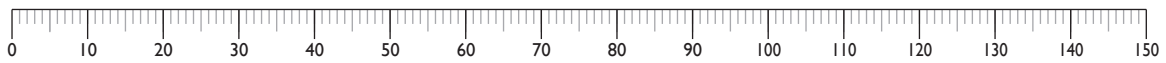

Cloverleaf TTO/TPLO Plates



TPLO202026
(2.0)



TPLO202031
(2.0)

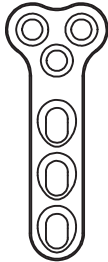

TPLO242434
(2.4)



TPLO242441
(2.4)

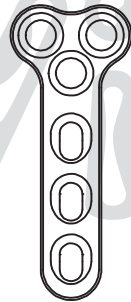

TPLO272739
(2.7)

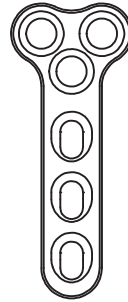

TPLO273539
(2.7/3.5)

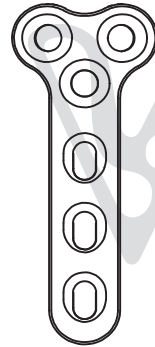

TPLO272745
(2.7)

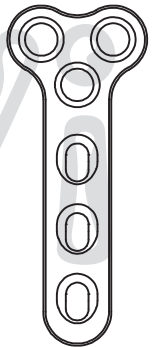

TPLO273545
(2.7/3.5)

**Locking plates
also available**

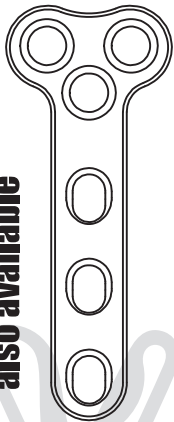

TPLO353555
(3.5)

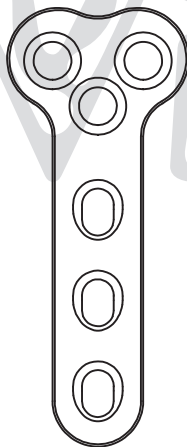

TPLO353557
(3.5 broad)

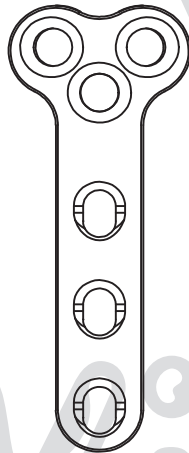

TPLO353559
(3.5)

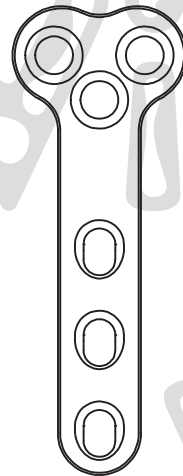

TPLO353562
(3.5)

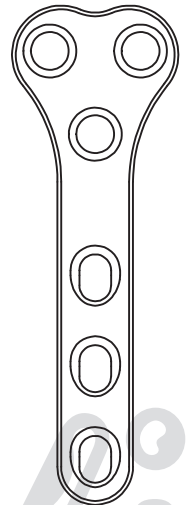

TPLO353565
(3.5)

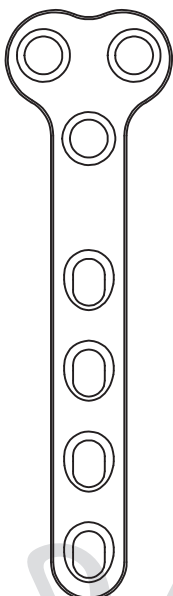

TPLO353577
(3.5)

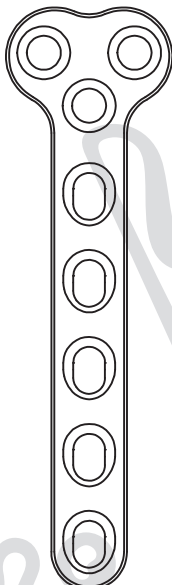

TPLO353577X
(3.5)

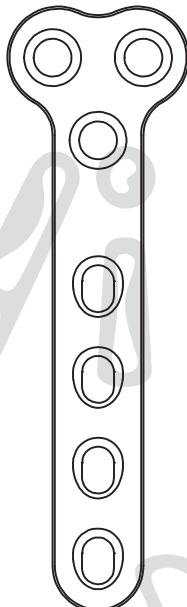

TPLO353579
(3.5 broad)

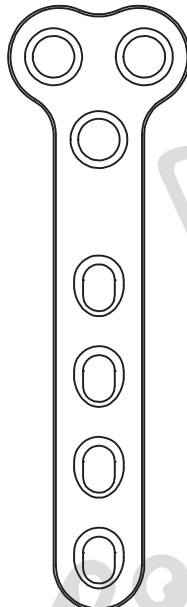

TPLO354579
(3.5 broad/4.5)

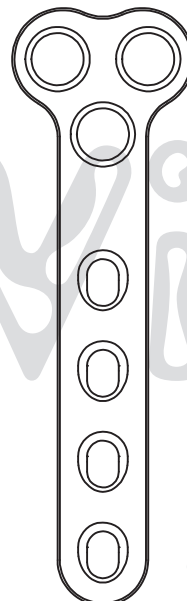

TPLO35456579
(3.5/4.5/6.5)

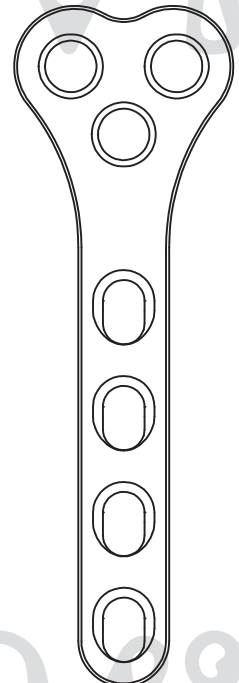

TPLO45659030/35/45
(4.5/6.5)
3mm, 3.5mm &
4.5mm thick

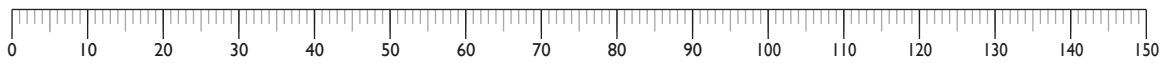

Slocum Style TPLO Plates

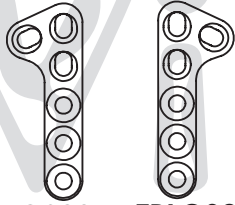

**TPLOS20R
(2.0)**

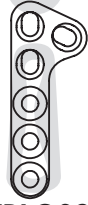

**TPLOS20L
(2.0)**

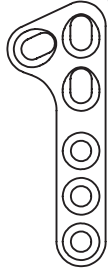

**TPLOS24R
(2.4)**

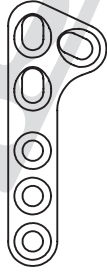

**TPLOS24L
(2.4)**

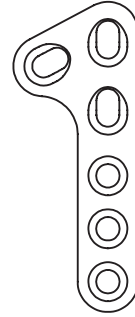

**TPLOS27R
(2.7)**

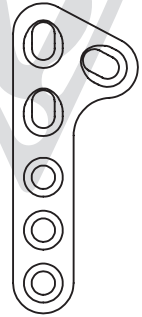

**TPLOS27L
(2.7)**



**TPLOS27BR
(2.7 broad)**

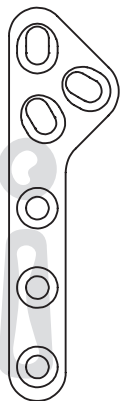

**TPLOS27BL
(2.7 broad)**

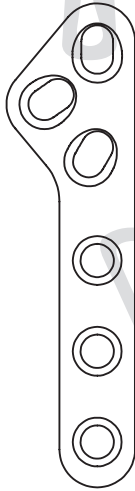

**TPLOS35R
(3.5)**

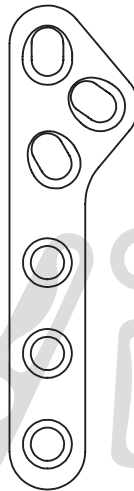

**TPLOS35L
(3.5)**

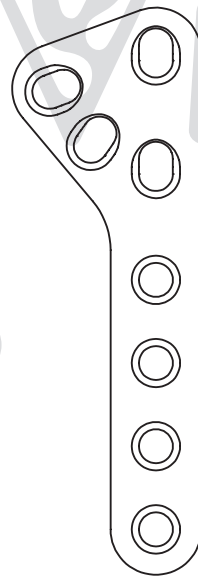

**TPLOS35BR
(3.5 broad)**

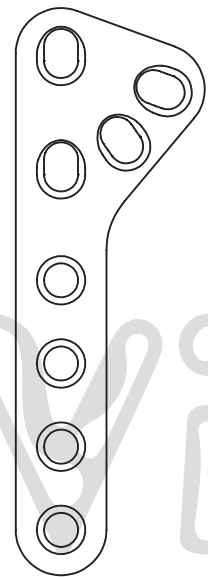

**TPLOS35BL
(3.5 broad)**

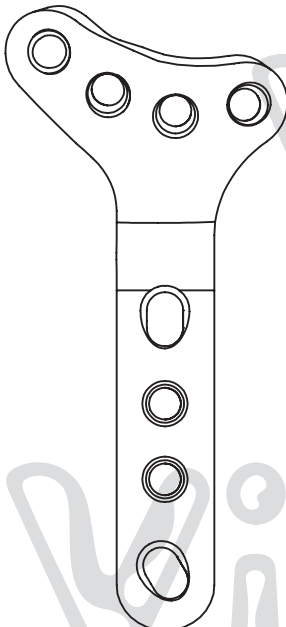

**TPLO35BLPCR
(3.5 broad)**

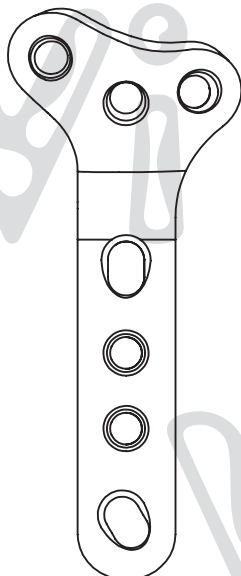

**TPLO35MLPCR
(3.5)**

Locking TPLO Plates

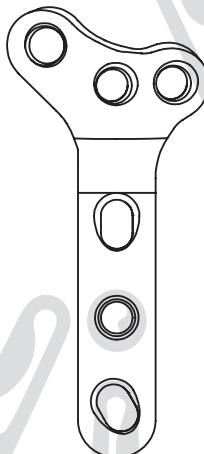

**TPLO35LPCR
(3.5)**

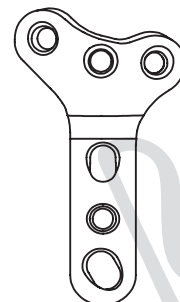

**TPLO27LPCR
(2.7)**

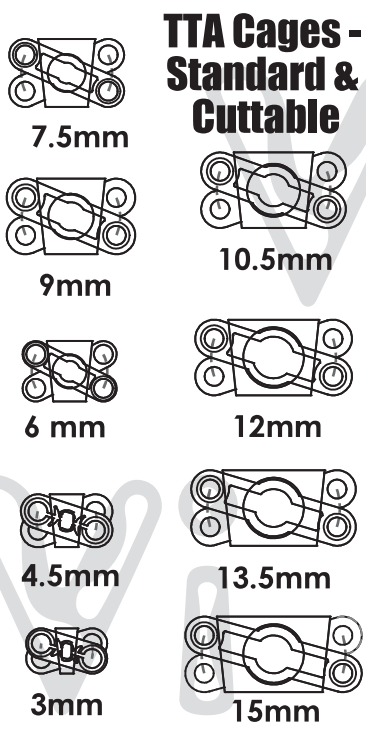
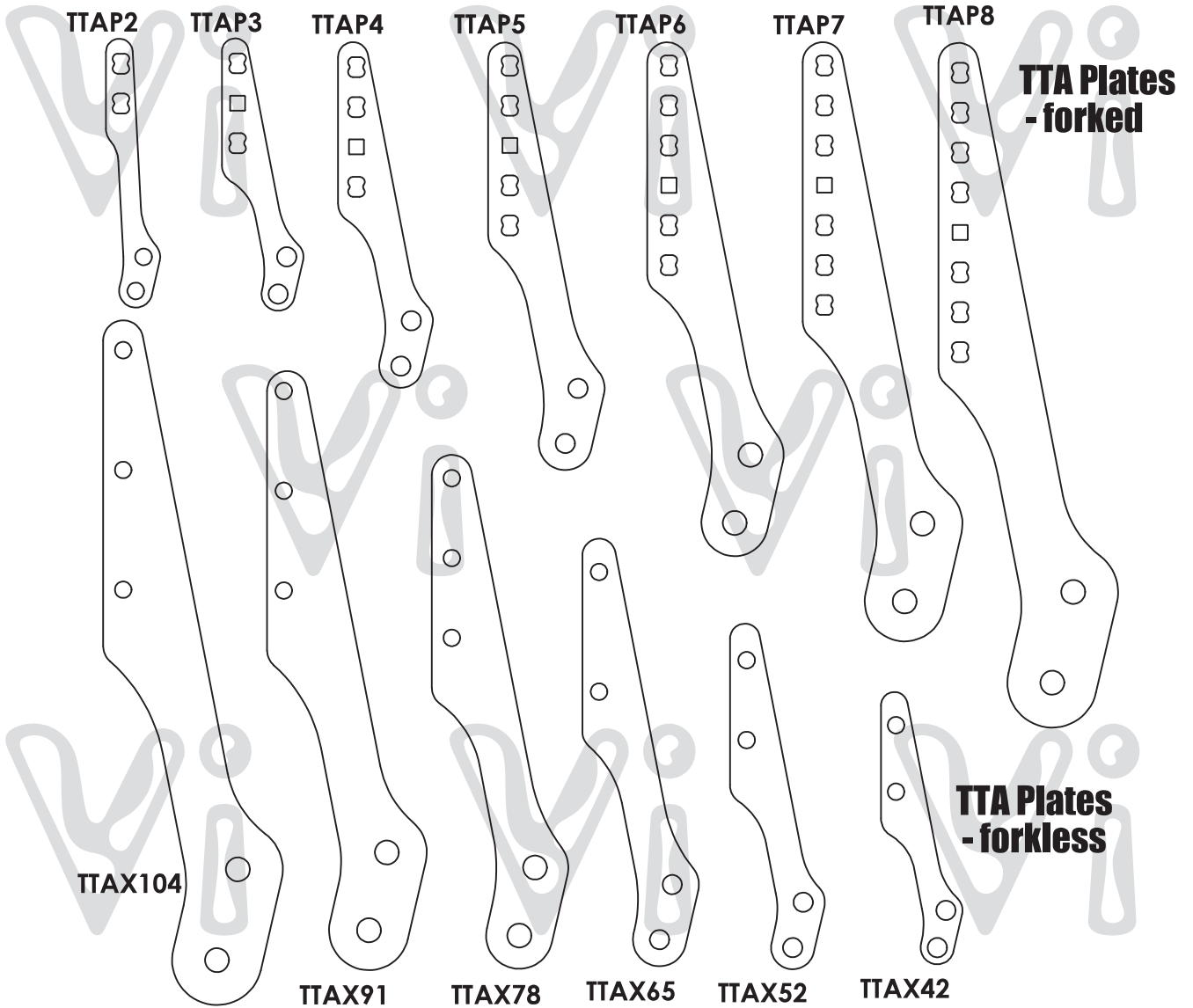
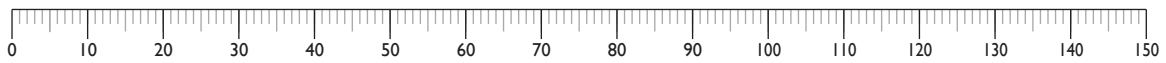

TTA Cages - Standard & Cuttable

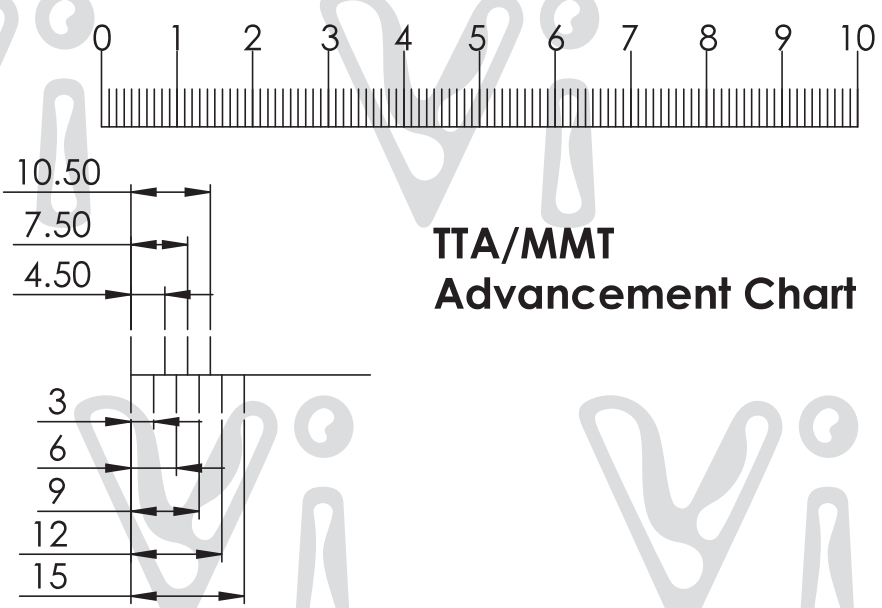

TTA/MMT Advancement Chart

PLEASE NOTE THAT PLATE PROFILES ARE ACTUAL SIZE YOU WILL NEED TO COMPENSATE FOR X-RAY MAGNIFICATION • PROFILES FOR GUIDANCE ONLY PLATES MAY BE AMENDED AT ANY TIME